



Lorien



Diagnostics

Periodontology

Surgery

Implant

Extraction

Restorative

Orthodontics

Instruments Management

[www.lorieninstruments.com](http://www.lorieninstruments.com)

# Diagnostics

Mirrors  
Explorers  
Probes  
Dressing Pliers  
Syringes



Lorien



## Spreaders Diagnostics Kits

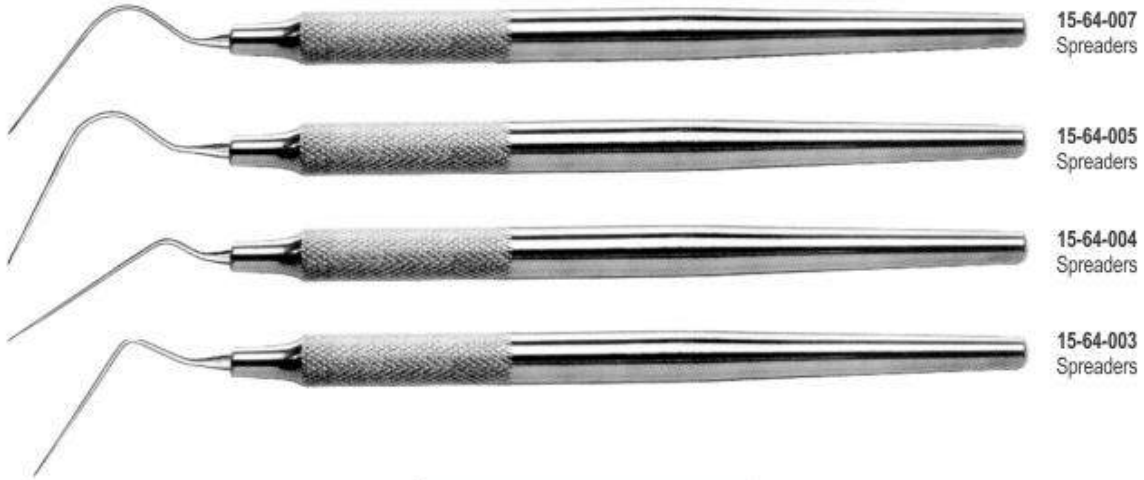

15-64-007  
Spreaders

15-64-005  
Spreaders

15-64-004  
Spreaders

15-64-003  
Spreaders

### Diagnostics Kits

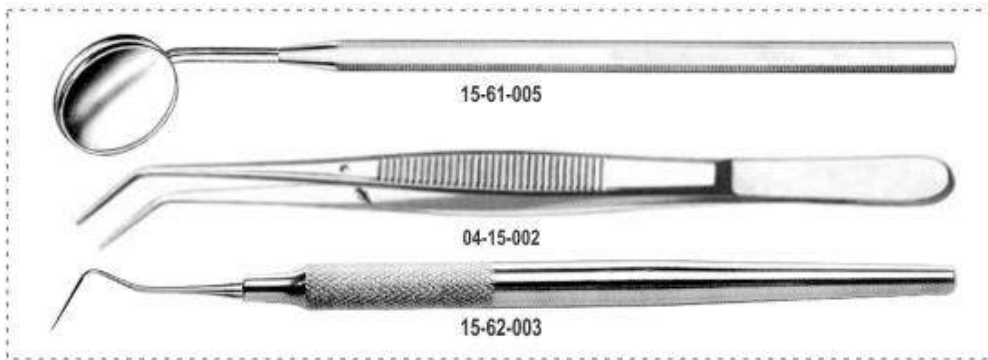

15-61-005

04-15-002

15-62-003

18-98-093  
Basic Examination Kit



- 1 x Instruments Cassette
- 1 x College Tweezer
- 1 x Explorer
- 1 x Perio Probe
- 1 x Mirror Handle & Mirror

18-98-094  
Diagnostics Kit



14-60-001 (1.8ml)  
14-60-015 (2.2ml)



14-60-002 (1.8ml)  
14-60-016 (2.2ml)



14-60-003 (1.8ml)  
14-60-017 (2.2ml)



14-60-005 (1.8ml)  
14-60-020 (2.2ml)



14-60-009 (1.8ml)  
14-60-018 (2.2ml)



14-60-010 (1.8ml)  
14-60-019 (2.2ml)



14-60-035 (1.8ml)



14-60-012 (1.8ml)  
Angled



14-60-004 (1.8ml) Straight  
14-60-024 (2.2ml) Straight  
14-60-013 (1.8ml) Angled  
14-60-023 (2.2ml) Angled



14-60-014 (1.8ml)  
14-60-025 (2.2ml)



14-60-006 (1.8ml)  
14-60-026 (2.2ml)

# Periodontology

Curettes  
Scalers  
Chisels  
Files



Lorien



Titanium





- 1 x Instruments Cassette
- 1 x Gracey 5-6
- 1 x Gracey 7-8
- 1 x Gracey 11-12
- 1 x Gracey 13-14
- 1 x Scaler H6-H7

**18-98-095**  
Basic Periodontology Kit



- 1 x Instruments Cassette
- 1 x Gracey 1-2
- 1 x Gracey 7-8
- 1 x Gracey 11-12
- 1 x Gracey 13-14
- 1 x Columbia 13-14
- 1 x Scaler H6-H7
- 1 x Scaler 204S
- 1 x Perio Probe CP12B
- 1 x Mirror Handle & Mirror

**18-98-096**  
Periodontology Kit

## Surgery

Scalpel Handles & Blades

Micro Surgery Instruments

Scissors

Needle Holders

Tissue Pliers

Haemostatic Forceps

Retractors

Periodontal Instruments

Mallets

Bone Curettes, Files

Bone Rongeurs

Bone Aspirators, Carriers



Lorien



## Micro Instruments



### Micro Needle Holders

20-101-039 straight 14cm  
20-101-040 curved 14cm  
20-101-015 straight 17cm  
20-101-016 curved 17cm

### Micro Scissors

20-101-041 straight 14cm  
20-101-042 curved 14cm  
20-101-013 straight 17cm  
20-101-014 curved 17cm

### Micro Tissue Forceps

20-101-037 straight 14cm  
20-101-038 curved 14cm  
20-101-017 straight 17cm  
20-101-018 curved 17cm

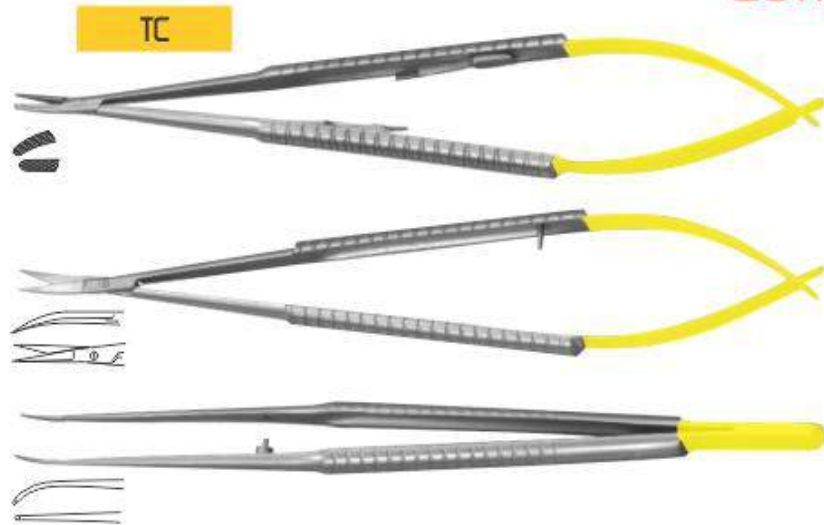

### Micro Needle Holders

20-101-101 Straight 17cm  
20-101-102 Curved 17cm

### Micro Scissors

20-101-103 Straight 17cm  
20-101-104 Curved 17cm

### Micro Tissue Forceps

20-101-105 Straight 17cm  
20-101-106 Curved 17cm

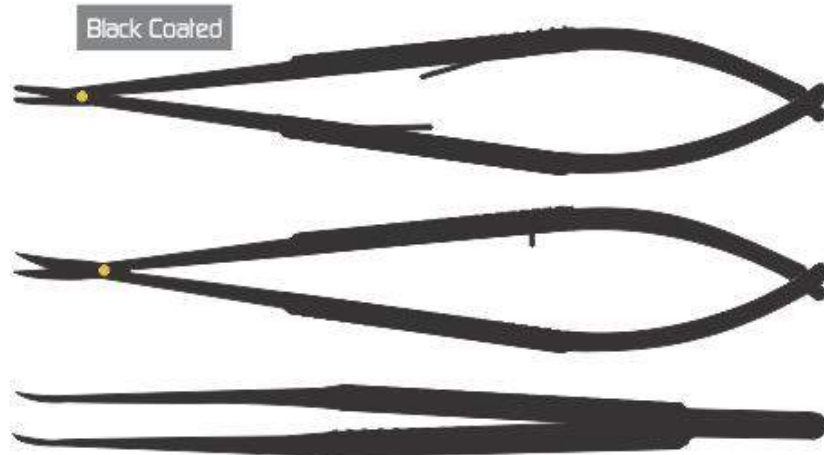

### Micro Needle Holders

20-101-033 Straight 14cm  
20-101-034 Curved 14cm  
20-101-021 Straight 17cm  
20-101-022 Curved 17cm

### Micro Scissors

20-101-035 Straight 14cm  
20-101-036 Curved 14cm  
20-101-019 Straight 17cm  
20-101-020 Curved 17cm

### Micro Tissue Forceps

20-101-031 Straight 14cm  
20-101-032 Curved 14cm  
20-101-023 Straight 17cm  
20-101-024 Curved 17cm

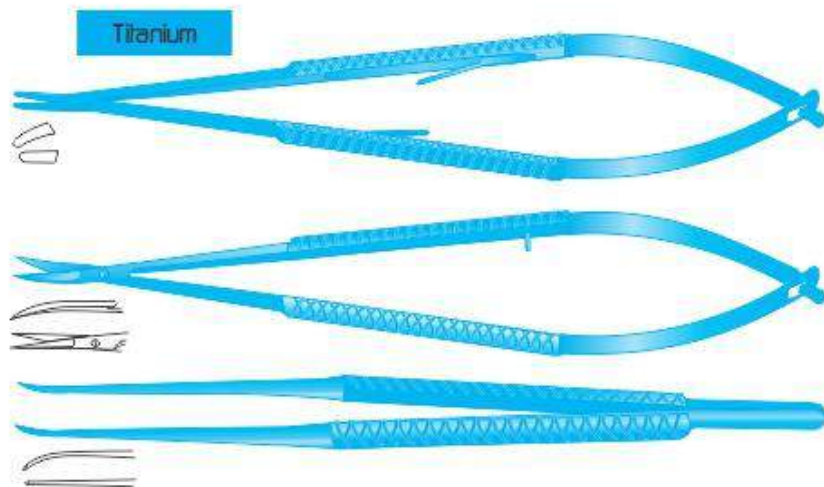



Titanium

**De Bakay Forceps**  
 20-101-071 Curved 17cm  
 20-101-072 Straight 17cm



**Implant Holding Tweezer**  
 20-101-053 16cm



21-103-037 College Tweezer 15cm



Serrated

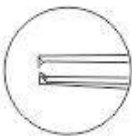

1x2 Teeth



21-103-030 Micro Adson (Delicate Serrated, 12cm)

21-103-031 Micro Adson (Delicate 1x2 Teeth, 12cm)



Straight



Curved

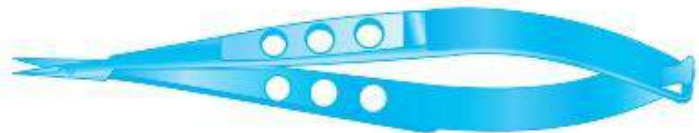

21-103-035 Micro Scissor (Straight, 8 mm Long Blades, 10cm)

21-103-036 Micro Scissor (Curved, 12mm Long Blades, 10cm)

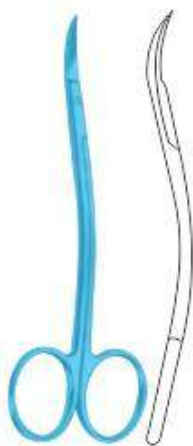

La Grange (11.5cm)  
 02-04-050



Glodmann Fox (13cm)  
 02-04-051 Str  
 02-04-052 Cvd

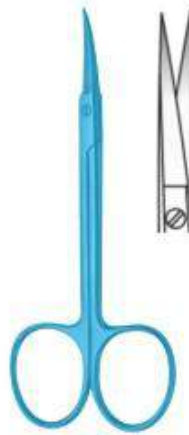

Iris (11.5cm)  
 02-04-053 Str  
 02-04-054 Cvd

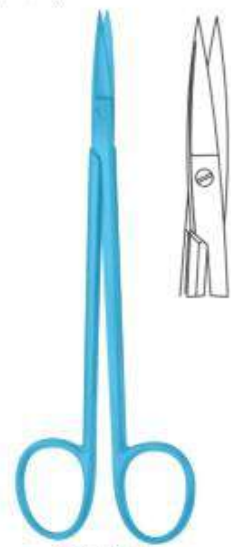

Kelly (16cm)  
 02-04-055 Str  
 02-04-056 Cvd

**Diamond Coated**

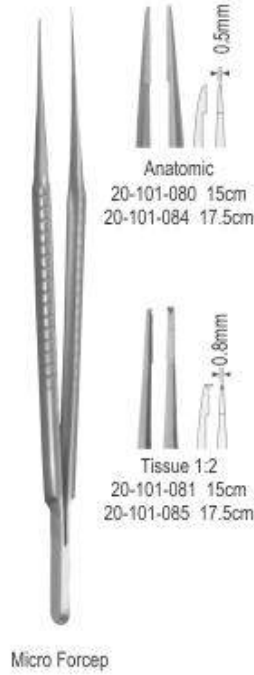
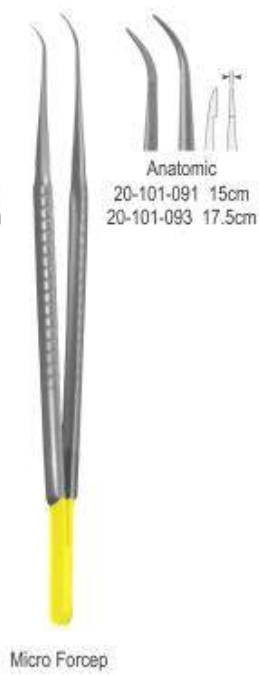

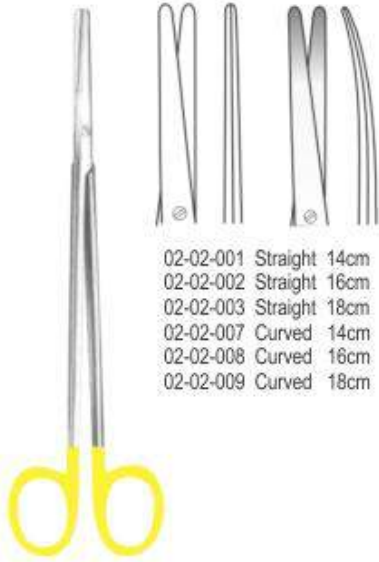

- 02-02-001 Straight 14cm
- 02-02-002 Straight 16cm
- 02-02-003 Straight 18cm
- 02-02-007 Curved 14cm
- 02-02-008 Curved 16cm
- 02-02-009 Curved 18cm

Metzenbaum

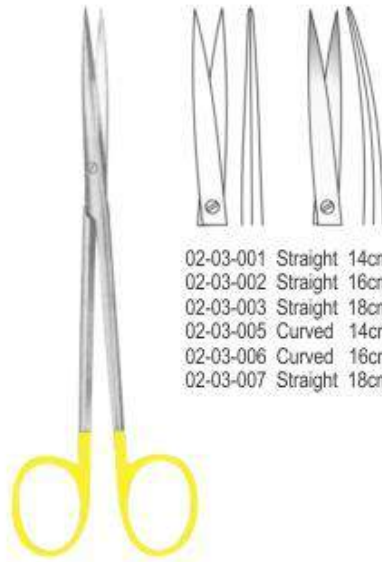

- 02-03-001 Straight 14cm
- 02-03-002 Straight 16cm
- 02-03-003 Straight 18cm
- 02-03-005 Curved 14cm
- 02-03-006 Curved 16cm
- 02-03-007 Straight 18cm

Metzenbaum-Fino

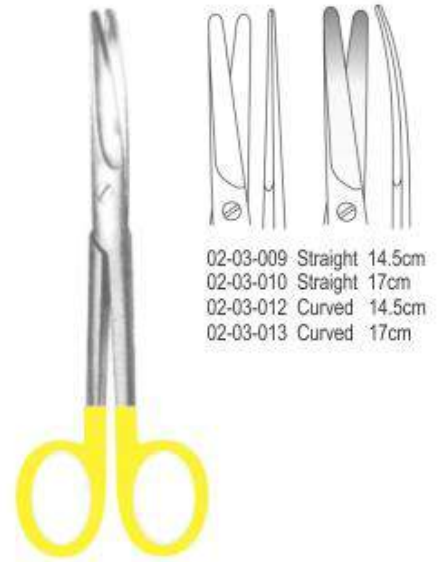

- 02-03-009 Straight 14.5cm
- 02-03-010 Straight 17cm
- 02-03-012 Curved 14.5cm
- 02-03-013 Curved 17cm

Mayo



- 02-04-008 Straight 16cm
- 02-04-009 Curved 16cm
- 02-05-011 Angled 16cm

Kelly



- 03-09-030 Straight 15cm
- 03-09-031 Curved 15cm

Noyes  
(Round Handle)

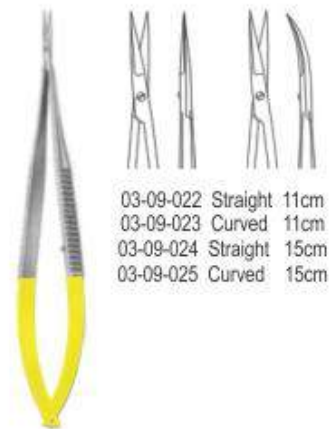

- 03-09-022 Straight 11cm
- 03-09-023 Curved 11cm
- 03-09-024 Straight 15cm
- 03-09-025 Curved 15cm

Noyes



- 02-04-003 Straight 11.5cm
- 02-04-004 Curved 11.5cm
- 02-04-023 Super-cut 11.5cm
- 02-04-005 Angled 11.5cm



Iris

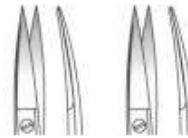

- 02-04-021 Standard 11.5cm
- 02-04-022 Super-cut 11.5cm



La Grange



- 02-04-025 Straight 10.5cm
- 02-04-026 Curved 10.5cm



Crown



- 02-04-001 Straight 13cm
- 02-04-002 Curved 13cm
- 02-04-024 Super-cut 13cm



Glodmann Fox

Black Coated



La Grange Scissor  
20-101-107  
11.5cm



Iris  
20-101-108 Str  
20-101-109 Cvd  
11.5cm



Goldman Fox  
20-101-110 Str  
20-101-111 Cvd  
13cm



Kelly Scissor  
20-101-112 Str  
20-101-113 Cvd  
16cm



## Mallets Periosteal Elevators



11-39-022  
with Autoclavable  
Silicone Beaks



11-39-023



11-39-037 210gm  
11-39-040 160gm  
with Autoclavable  
Silicone Beaks



11-39-038 200gm  
11-39-041 130gm



11-39-050  
with Autoclavable  
Silicone Beaks

### Periosteal Elevators



15-75-001  
Molt



15-75-003  
Prichard

### Titanium



21-103-014  
Molt 3/4



21-103-015  
Molt 5/6



21-103-010  
Molt



21-103-017  
Prichard

## Implant

Periosteal Elevators  
Sinus Lift Elevators  
Bone Grafting Instruments  
Bone Crushers & Wells  
Osteotomes  
Bone Splitting Chisels  
Ratchets & Drivers  
Trepines, Punches, Drills & Expanders



Lorien

## Sinus-Lift Elevators



23-106-011 Sinus 1



23-106-012 Sinus 2



23-106-013 Sinus 3



23-106-014 Sinus 4



23-106-015 Sinus 5



23-106-016 Sinus 6



23-106-017 Sinus 7 (Optional)

- 1 x Sinus 1
- 1 x Sinus 2
- 1 x Sinus 3
- 1 x Sinus 4
- 1 x Sinus 5
- 1 x Sinus 6
- 1 x Sinus 7



18-98-072  
Sinus Lifting Kit  
(Set of 7 Pieces)





**Concave**

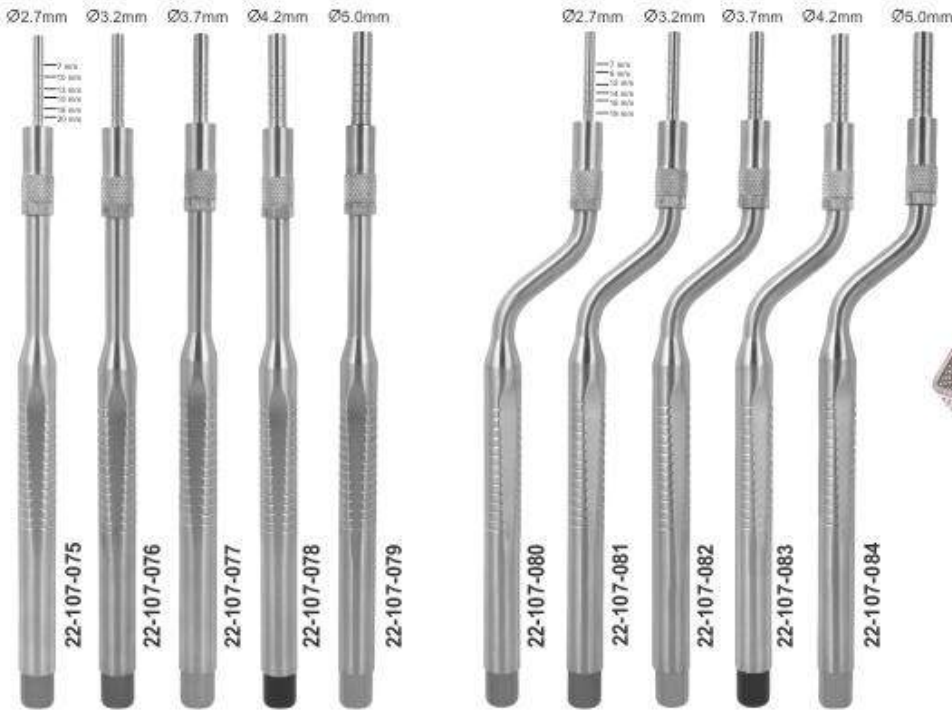

**22-107-085**  
Osteotome Kit  
Set of 10 Pieces

Adjustable Osteotomes

IMPLANTS

**Round**



**22-107-096**  
Osteotome Kit  
Set of 10 Pieces



Adjustable Osteotomes

### Bone Splitting Chisels



**22-107-144**  
Bone Splitting Kit  
Set of 7 Pieces

### Ratchets

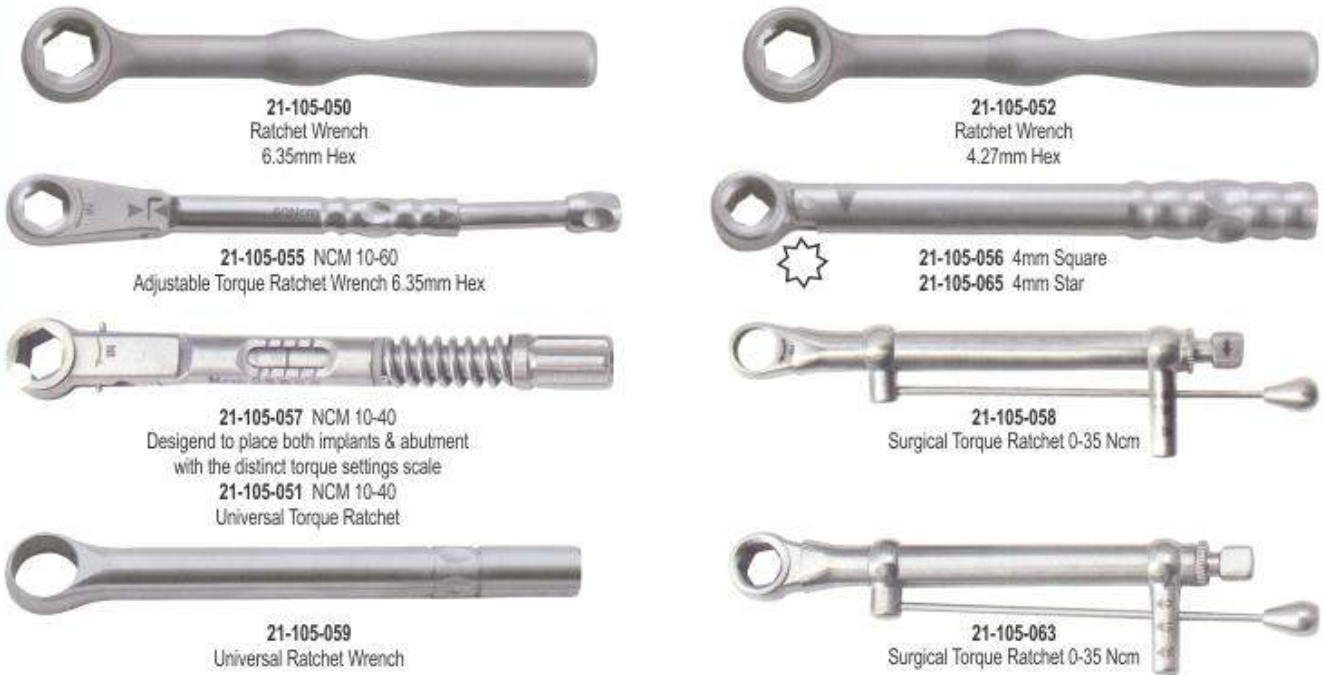

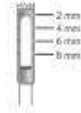

Fig / Art.No	21-105-031	21-105-110	21-105-032	21-105-111	21-105-033	21-105-112	21-105-034
Length mm	8	8	8	8	8	8	8
	2.00	2.50	3.00	3.50	4.00	4.50	5.00
	3.00	3.50	4.00	4.50	5.00	5.50	6.00



Fig / Art.No	21-105-113	21-105-035	21-105-114	21-105-036	21-105-115	21-105-037	21-105-038
Length mm	8	8	8	8	8	8	8
	5.50	6.00	6.50	7.00	7.50	8.00	9.00
	6.50	7.00	7.50	8.00	8.50	9.00	10.00



Fig / Art.No	21-105-116	21-105-117	21-105-118	21-105-119	21-105-120	21-105-121
Length mm	14	14	14	14	14	14
	3.00	3.50	4.00	4.50	5.00	5.50
	4.00	4.50	5.00	5.50	6.00	6.50



Fig / Art.No	21-105-122	21-105-123	21-105-124	21-105-125	21-105-126
Length mm	14	14	14	14	14
	6.00	6.50	7.00	7.50	8.00
	7.00	7.50	8.00	8.50	9.00

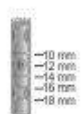

Fig / Art.No	21-105-127	21-105-128	21-105-129	21-105-130	21-105-131	21-105-132	21-105-133	21-105-134
Length mm	18	18	18	18	18	18	18	18
	3.00	3.50	4.00	4.50	5.00	6.00	7.00	8.00
	4.00	4.50	5.00	5.50	6.00	7.00	8.00	9.00



21-105-031  
21-105-032  
21-105-033  
21-105-034

18-99-110  
Trephine Drill Stand  
4 Holes



21-105-031  
21-105-032  
21-105-033  
21-105-034  
21-105-035  
21-105-036  
21-105-037  
21-105-038

21-105-039  
Trephine Drill Stand  
8 Holes



18-99-054  
Trephine Drill Stand  
8 Holes



18-99-055  
Trephine Drill Stand  
12 Holes



Depth Gauge

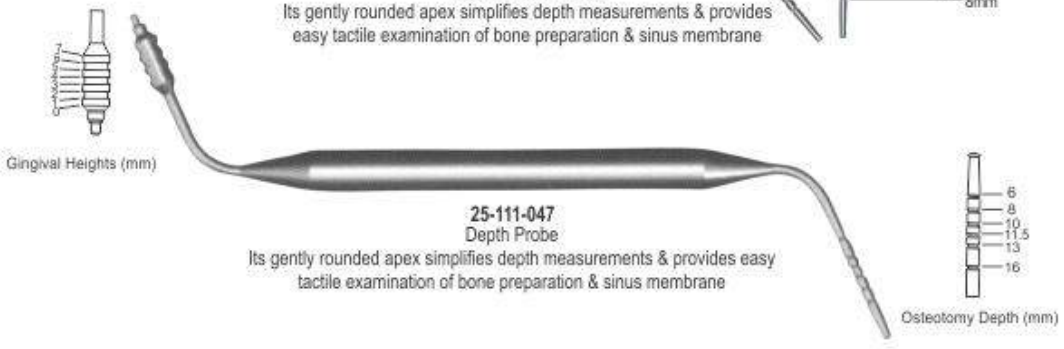
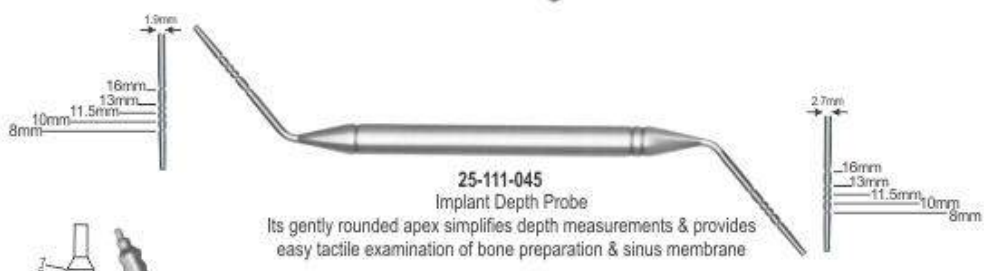
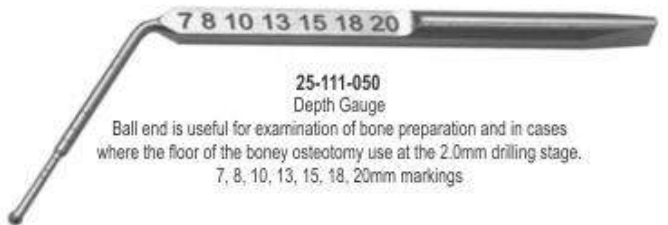

Implants Kits



IMPLANTS





- 18-98-078**  
**Basic Implant Kit**  
Instruments Cassette  
Crile Wood Needle Holder TC  
La Grange Scissor TC  
Adson Tissue Forcep TC  
Periotomes Set  
Scalpel Handle  
Buser Periosteal Elevator  
Prichard Periosteal Elevator  
Lucas Bone Curette  
De Bakay Tissue Forcep  
Suture Forcep  
Universal Retractor  
University of Minnesota Retractor

# Extraction

Extracting Forceps  
Root Elevators  
Luxators  
Periotomes



Lorien



Anatomical Handle

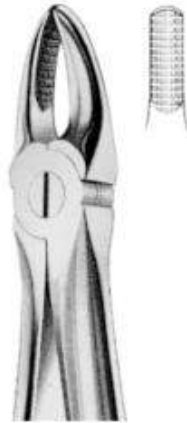

12-43-001  
Upper Central and canines  
Fig. 1



12-43-003  
Upper laterals and canines  
Fig. 2



12-43-002  
Upper Premolars  
Fig. 7



12-43-005  
Upper Molars Right  
Fig. 17



12-43-006  
Upper Molars Left  
Fig. 18



12-43-010  
Upper Molars Either Side  
Fig. 18 A



12-47-004  
Upper Molars Right  
Fig. 89



12-47-003  
Upper Molars Left  
Fig. 90



12-45-001  
Upper Third Molars  
Fig. 67A



12-47-009  
Upper Third Molars Right  
Fig. 67R



12-47-010  
Upper Third Molars Left  
Fig. 67L



## Luxating Sets



**22-107-128**  
Set of 7 Pieces

Fine Micro Serrations to Loosen the Tooth from the Socket & Periodontal Ligament.



**22-107-136**  
Set of 7 Pieces



Fine Micro Serrations to Loosen the Tooth from the Socket & Periodontal Ligament.  
Coated with Blue Titanium for Extra Strength & Durability During Extraction.

EXTRACTION

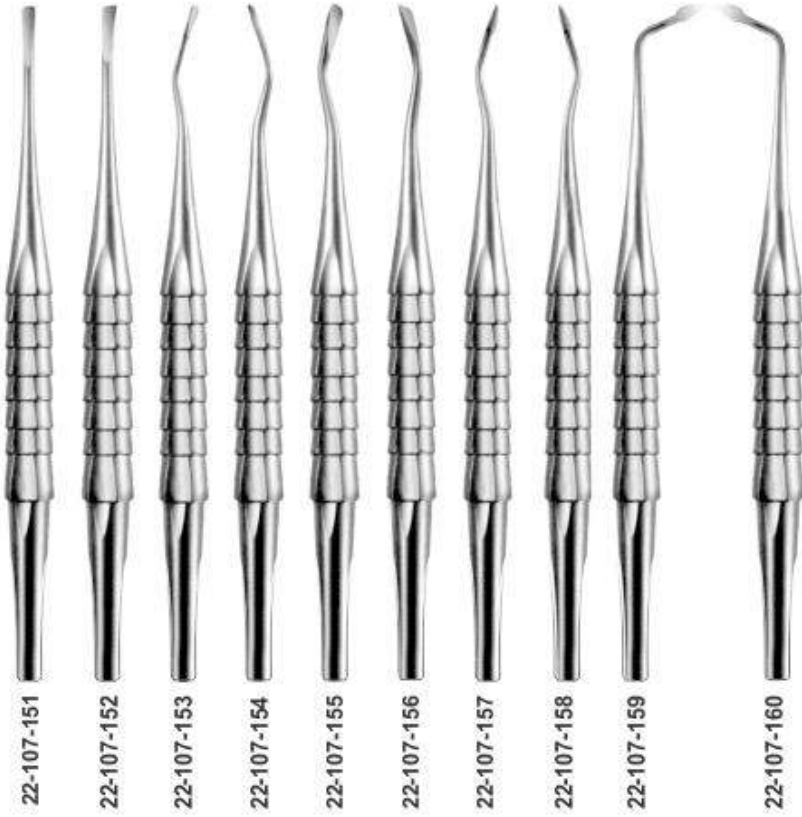

**22-107-161**  
Luxating Kit  
Set Of 10 Pieces

Periotomes

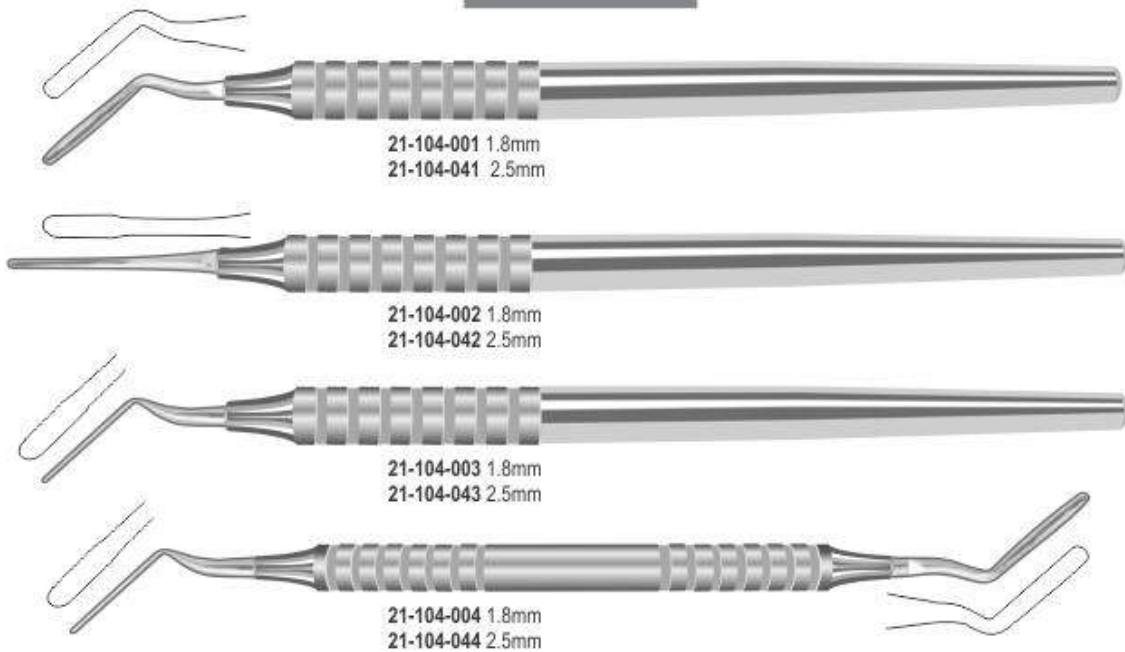

## Restorative

Composite Instruments

Filling Instruments

Excavators

Amalgam Instruments

Wax & Modelling Carvers

Wax/Plaster Knives & Spatulas

Crown Instruments

Measuring Instruments

Matrix Retainers

Rubber Dam Instruments

Impression Trays



Lorien

Titanium Nitride (TiN) Coated

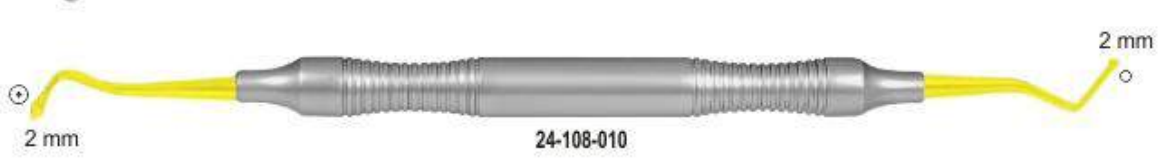
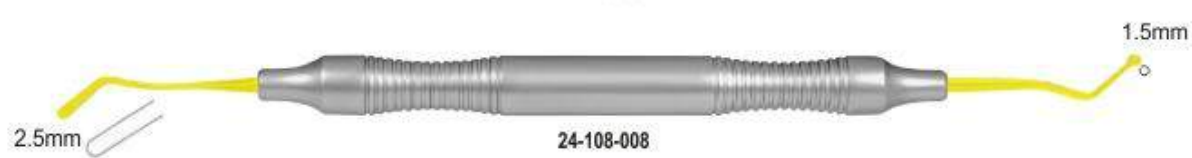
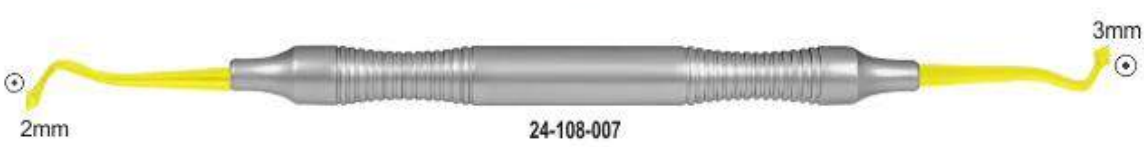
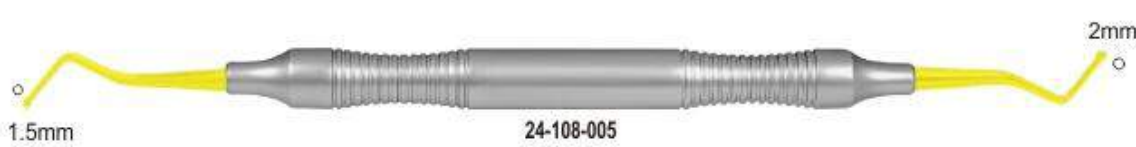
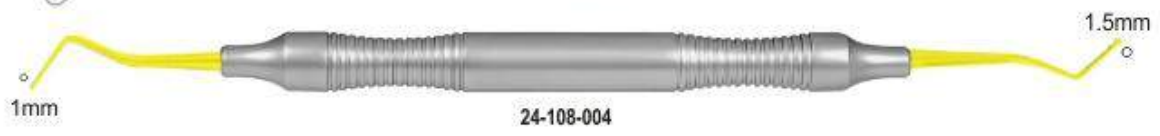
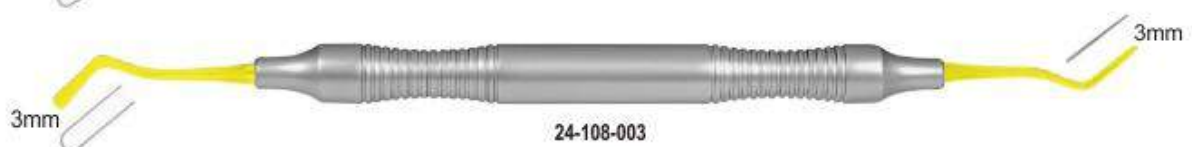

Heidemann Spatulas

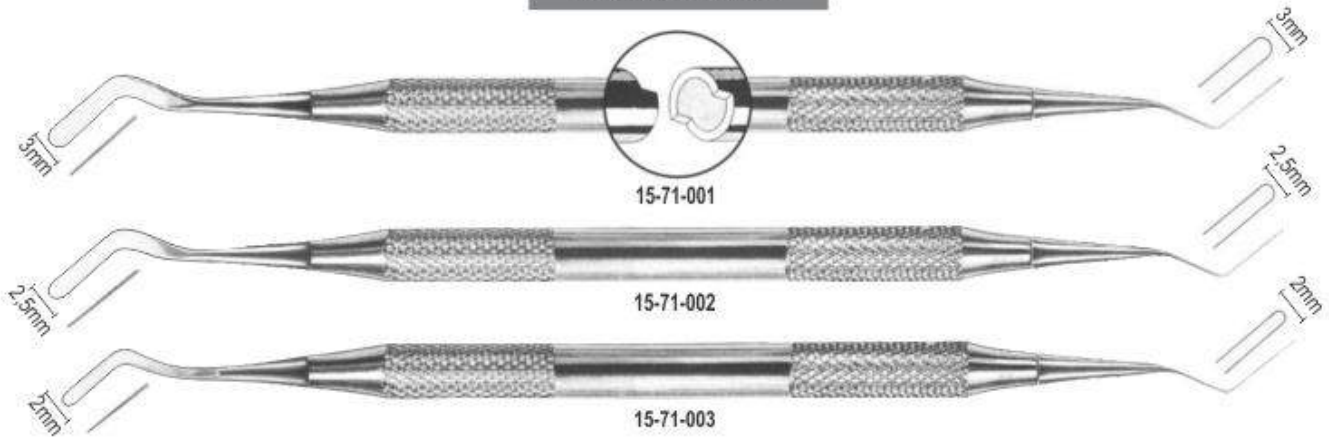

Cement Spatulas

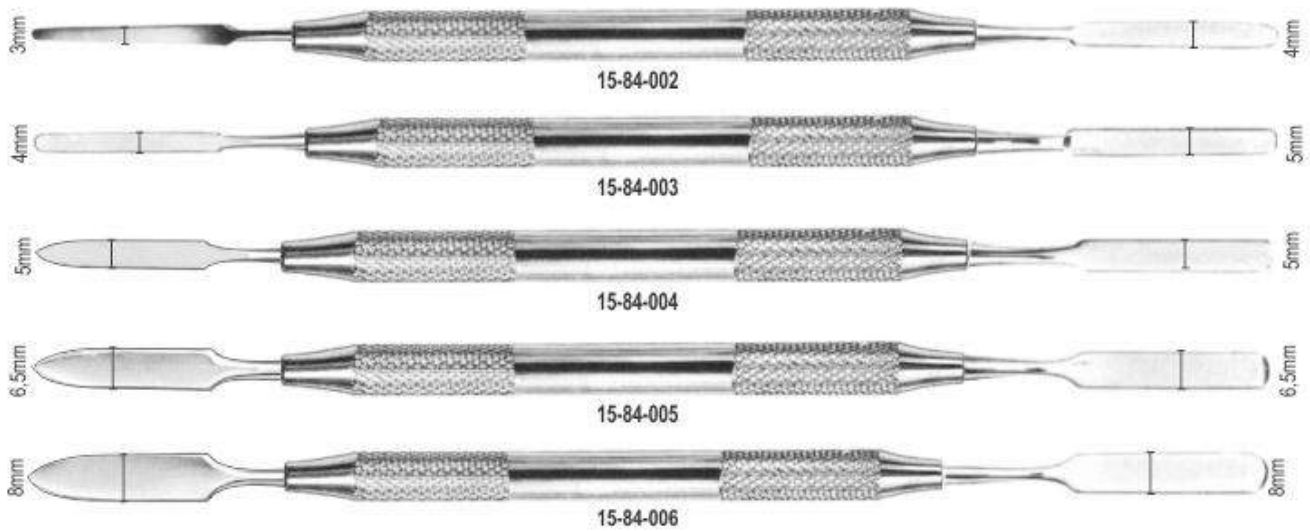

Burnishers

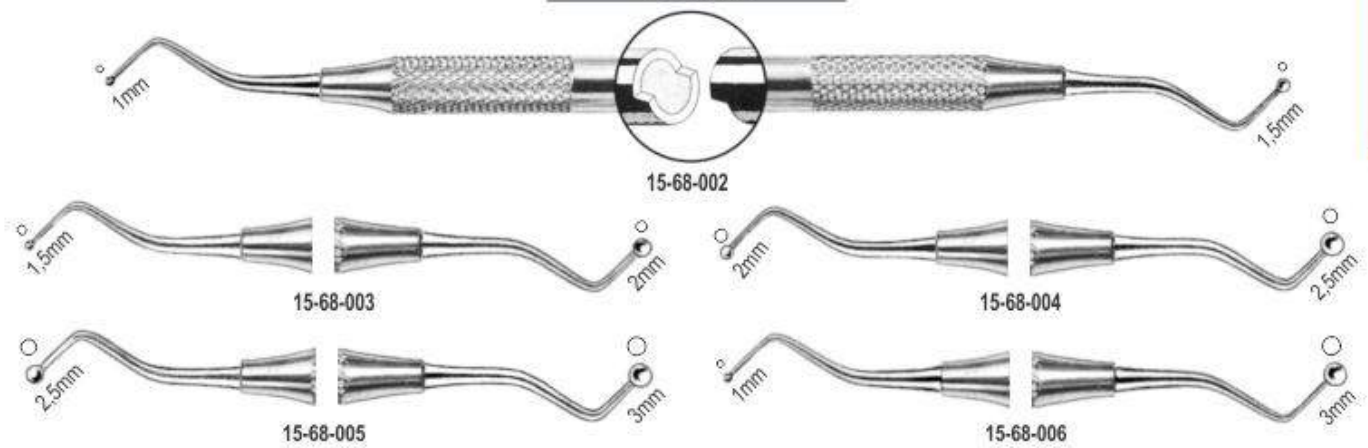



**06-28-005**  
Bone Calliper



**06-28-003**  
Bone Calliper



**06-28-002**  
Iwanson Metal



**06-28-004**  
Iwanson Wax

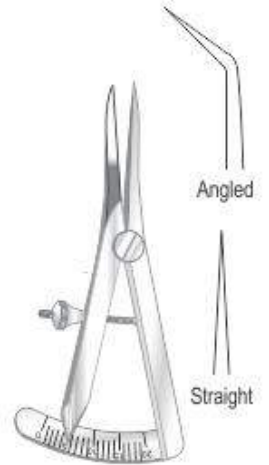

Castroviejo  
**06-28-006** 9cm (0-20mm) Straight  
**06-28-012** 9cm (0-20mm) Angled  
**06-28-014** 17cm (0-40mm) Straight  
**06-28-013** 17cm (0-40mm) Angled



**06-28-001**  
Boly



**25-111-053**



**25-111-054**



**25-111-051**  
Facilitates Positioning  
of Implants Measures



**25-111-052**  
Facilitates Positioning  
of Implants Measures



**06-28-015 Str**  
**06-28-016 Ang**  
17cm (0-40mm)

# Stainless Steel Impression Trays



Without Rim-Lock



19-96-001  
Anterior Left



19-96-002  
Anterior Right

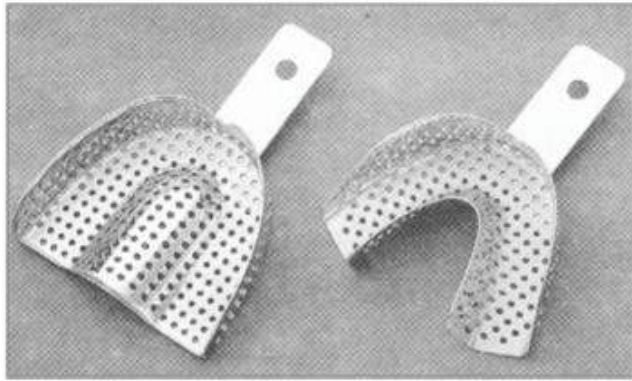

19-96-004 (Upper)

19-96-003 (Lower)

		mm	mm
U0	xxs	63	48
U1	xs	65	52
U2	s	68	54
U3	M	71	58
U4	L	73	59
U5	XL	78	63

		mm	mm
L0	xxs	56	44
L1	xs	66	50
L2	s	70	52
L3	M	73	56
L4	L	76	58
L5	XL	78	60

		mm	mm
U0	xxs	63	48
U1	xs	65	52
U2	s	68	54
U3	M	71	58
U4	L	73	59
U5	XL	78	63

		mm	mm
L0	xxs	56	44
L1	xs	66	50
L2	s	70	52
L3	M	73	56
L4	L	76	58
L5	XL	78	60

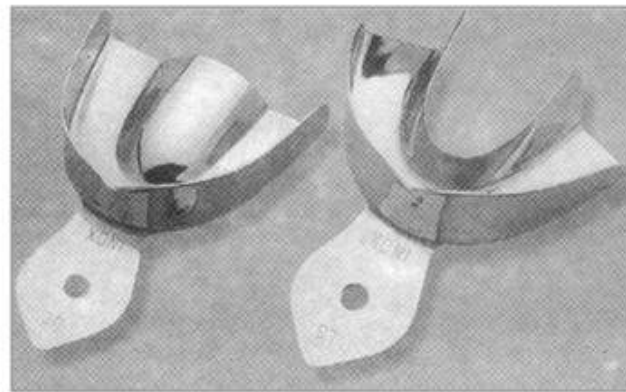

19-96-005 (Upper)

19-96-006 (Lower)



19-96-007  
Anterior Right



19-96-008  
Anterior Left

Full Denture Perforated

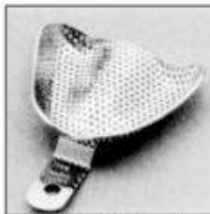

19-97-015 (Upper)

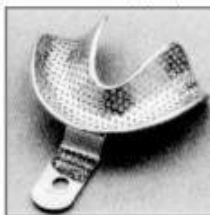

19-97-016 (Lower)

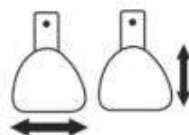

MM.	MM.
L 79	70
M 76	67
S 73	60

MM.	MM.
L 79	70
M 76	67
S 73	60

Full Denture Solid



19-97-017 (Upper)

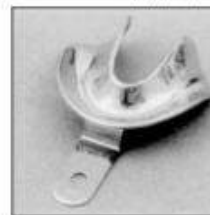

19-97-018 (Lower)

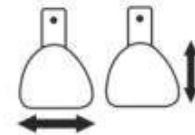

MM.	MM.
L 79	70
M 76	67
S 73	60

MM.	MM.
L 79	70
M 76	67
S 73	60

RESTORATIVE

With Rim-Lock



19-97-000  
(Upper)

19-97-012  
(Partial Moving)

19-97-001  
(Lower)

		mm	mm
U0	xxs	63	48
U1	xs	65	52
U2	s	68	54
U3	M	71	58
U4	L	73	59
U5	XL	78	63

		mm	mm
L0	xxs	56	44
L1	xs	66	50
L2	s	70	52
L3	M	73	56
L4	L	76	58
L5	XL	78	60



19-97-004 (Partial Upper)

19-97-006 (Partial Lower)

19-97-005 (Anterior Right)

19-97-007 (Anterior Left)



19-97-002  
(Upper)

19-97-013  
(Partial Moving)

19-97-003  
(Lower)

		mm	mm
U0	xxs	63	48
U1	xs	65	52
U2	s	68	54
U3	M	71	58
U4	L	73	59
U5	XL	78	63

		mm	mm
L0	xxs	56	44
L1	xs	66	50
L2	s	70	52
L3	M	73	56
L4	L	76	58
L5	XL	78	60



19-97-009 (Anterior Right)

19-97-011 (Anterior Left)

19-97-010 (Partial Upper)

19-97-008 (Partial Lower)



# Orthodontics

Orthodontic Pliers  
Orthodontic Instruments  
Ligature Instruments



Lorien



18-93-001  
Langenback



18-93-002  
Golsee



21-102-045  
Bird Beak



21-102-036  
Double Round Jaw



18-93-005  
Tweed Arch Forming Plier



18-93-006  
Tweed



18-93-007  
3 Jaw Aderer



21-102-014  
Light Wire Plier



21-102-042  
Arch Forming and  
Contouring



21-102-032  
'V' Bend Stop



21-102-034  
Hook Crimping  
Straight



21-102-013  
Adams



**21-102-027**  
Ortho Scaler Sickle



**21-102-029**  
Gingrass Ligature Director



**21-102-061**  
Band Pusher/Scaler



**21-102-062**  
Medium Plugger/ Ligature



**21-102-066**  
Picker/wide Ligature Director



**21-102-067**  
Ligature Director Plugger



**21-102-068**  
Fillion Explorer Ligature Director



**21-102-069**  
Ligature Director Tucker



**21-102-071**  
Band Pusher Scaler



**21-102-072**  
Gingrass Ligature Director

# Instruments Management

Holloware  
Cassettes & Trays



Lorien



**Medican Cup**  
18-99-004 (50 cc)  
18-99-005 (25 cc)

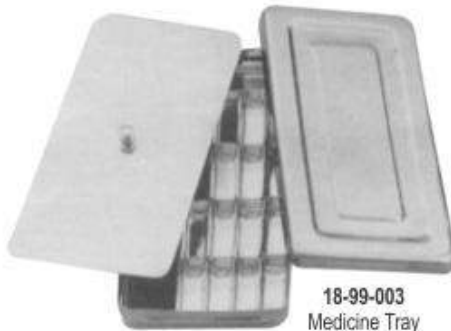

**18-99-003**  
Medicine Tray



18-99-008 180 x 80 x 40mm  
18-99-009 200 x 100 x 50mm



18-98-003 50x100mm  
18-98-004 50x130mm  
18-98-005 75x100mm  
18-98-006 75x130mm  
18-98-007 75x175mm  
Jar



**Universal Tray**  
18-98-012 (230x155x30mm)  
18-98-014 (300x175x40mm)



18-98-008 6"  
18-98-041 7"  
18-98-042 8"  
18-98-043 10"  
Kidney Tray



**18-98-047**  
Mini Cassette

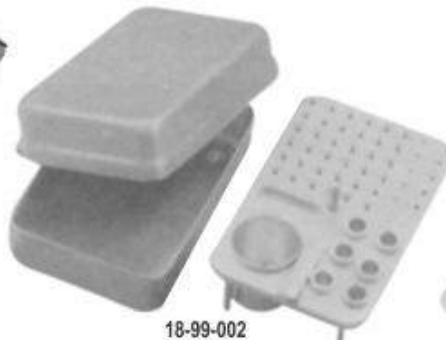

**18-99-002**  
Endo Box



**18-99-006**  
Scaler Tray



18-99-011 75x75mm  
18-99-012 100x100mm  
Dressing Jar



**Endo Box**  
18-99-007 100x45x55  
18-99-001 100x45x35



**18-99-050**  
Burs Holder  
18 Holes



**18-99-051**  
Burs Holder  
18 Holes



**18-99-052**  
Burs Holder  
18 Holes



**18-99-053**  
Burs Holder  
18 Holes



**18-99-020**  
Needle Sterilization Box



**18-99-030**  
94x62mm  
Bur Holders

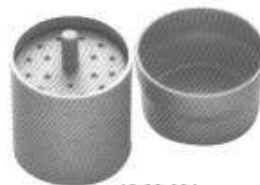

**18-99-031**  
48x70mm  
Bur Holders



**18-98-001**  
Alcohol Burner



**18-98-002**  
Cotton Holder

## Cassettes & Trays

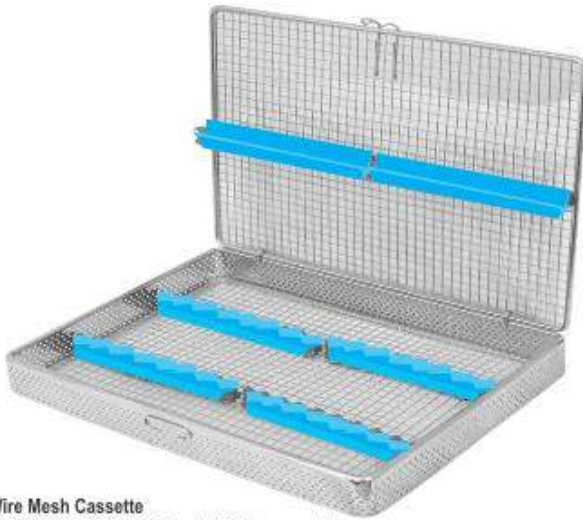

### Wire Mesh Cassette

- 18-98-103 (280x190x35mm) (20 Instruments)
- 18-98-102 (200x140x35mm) (10 Instruments)
- 18-98-101 (200x100x35mm) (7 Instruments)
- 18-98-100 (195x 80x35mm) (5 Instruments)



### Norm Tray (Base Perforated Lid Solid)

- 18-98-011 (280x180x40mm)
- 18-98-017 (180x140x40mm)



### Instruments Cassette

- 18-98-060 (290x185x35mm) (20 Instruments)
  - 18-98-061 (200x150x35mm) (10 Instruments)
  - 18-98-062 (200x 70x35mm) ( 5 Instruments)
- (Removable Cover, Twist Lock System)

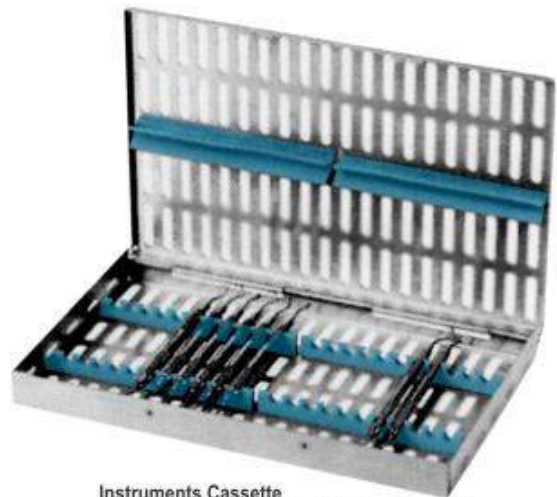

### Instruments Cassette

- 18-98-064 (285x190x30mm) (20 Instruments)
- 18-98-020 (185x125x25mm) (10 Instruments)
- 18-98-073 (185x90x25mm) (7 Instruments)
- 18-98-063 (185x65x25mm) (5 Instruments)

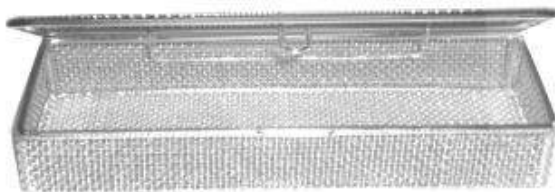

### Instruments Box

- 18-98-019
- (230x80x40mm)

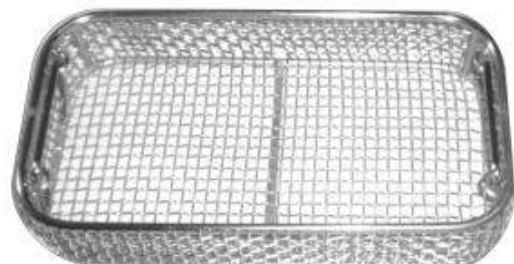

### Instruments Tray

- 18-98-018
- (240x130x50mm)