

P SERIES

ULTRASONIC SCALER

INSTRUCTION MANUAL

Please read the instruction manual carefully before operating



CE 0197

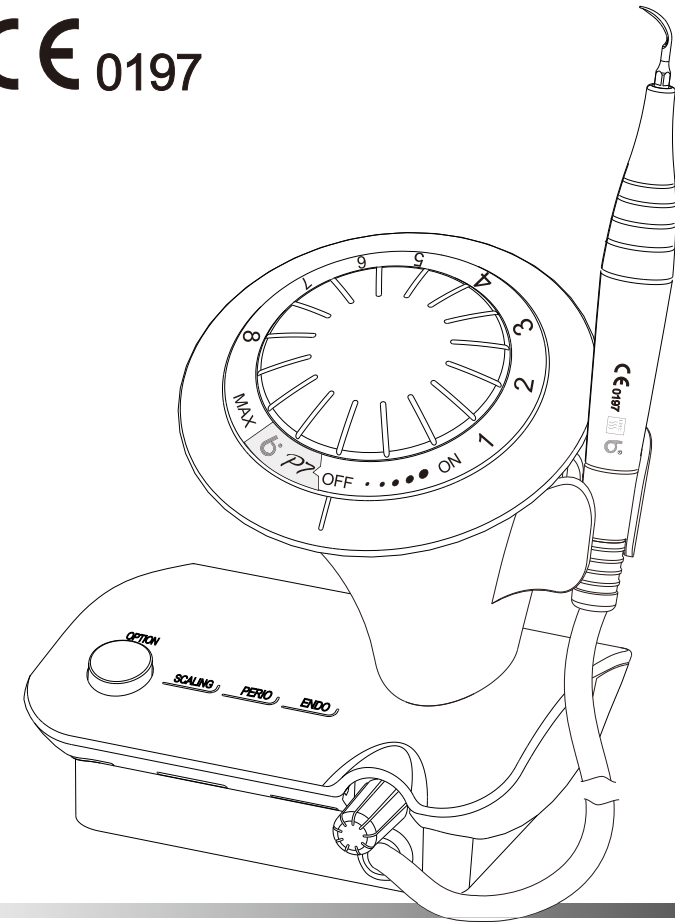

Well Kang Limited
The Black Church, St. Mary's
Place, Dublin 7, Ireland



NANNING BAOLAI MEDICAL INSTRUMENT CO., LTD
7th Floor, General Building, Hetai Sci. &Tech. Park, No.9
Gaoxin 4th RD., Nanning, Guangxi, 530007, China

Service Number: 0086-771-3815998 E-mail: info@boool.com
Fax Number: 0086-771-3217883 Web: www.boool.com

© Copyright Baolai PA-PX-M-E-1 Ver A8 Revision date: 20200826



P SERIES

ULTRASONIC SCALER

This manual is suitable for B6 & B6S & P6 & P7 & P7L ultrasonic scaler



www.boool.com























Let's make things better

Contents

1	Symbol instruction	1
2	Acquaintance of the product and its parts	2
3	Product structure, scope of application and contraindication	6
4	Components	7
5	Technical specifications	8
6	Usage	9
7	Sterilization	10
8	Precautions	12
9	Maintenance	13
10	Storage and transportation	14
11	After-service	15
12	Environmental protections	15
13	EMC–Declaration of conformity	16

Recommended separation distances between portable and mobile RF communications equipment and the models B6,B6S,P6,P7 and P7L			
The models B6, B6S, P6, P7 and P7L are intended for use in electromagnetic environment in which radiated RF disturbances is controlled. The customer or the user of the models B6, B6S, P6, P7 and P7L can help prevent electromagnetic interference by maintaining a minimum distance between portable and mobile RF communications equipment (transmitters) and the models B6, B6S, P6, P7 and P7L as recommended below, according to the maximum output power of the communications equipment.			
Rated maximum output power of transmitter W	Separation distance according to frequency of transmitter m		
	150kHz to 80MHz $d=1.2 \times P^{1/2}$	80MHz to 800MHz $d=1.2 \times P^{1/2}$	800MHz to 2,5GHz $d=2.3 \times P^{1/2}$
0,01	0.12	0.12	0.23
0,1	0.38	0.38	0.73
1	1.2	1.2	2.3
10	3.8	3.8	7.3
100	12	12	23
<p>For transmitters rated at a maximum output power not listed above, the recommended separation distance d in meters (m) can be estimated using the equation applicable to the frequency of the transmitter, where P is the maximum output power rating of the transmitter in watts (W) accordable to the transmitter manufacturer.</p> <p>NOTE 1 At 80 MHz and 800 MHz. the separation distance for the higher frequency range applies.</p> <p>NOTE 2 These guidelines may not apply in all situations. Electromagnetic propagation is affected by absorption and reflection from structures, objects and people.</p> <p>NOTE 3 An additional factor of 10/3 has been incorporated into the formulae used in calculating the recommended separation distance for transmitters in the ISM frequency bands between 150 kHz and 80 MHz and in the frequency range 80 MHz to 2,5 Ghz to decrease the likelihood that mobile/portable communications equipment could cause interference if it is inadvertently brought into patient areas.</p> <p>NOTE 4 These guidelines may not apply in all situations. Electromagnetic propagation is affected by absorption and reflection from structures, objects and people.</p>			

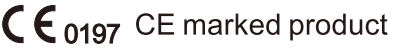
1 Symbol instruction

	Trademark		Caution
	Class II equipment		Follow instructions for use
	Type B applied part		30VDC input
	Alternating current		Water control switch
	Foot switch		Water entrance 0.1-0.5MPa 0.1MPa~0.5MPa(1bar~5bar)
	Use indoor only		Appliance compliance with WEEE directive
	Autoclavable		IPX0 Ordinary equipment
	Date of manufacture		IPX1 Drop-proof
	Serial number		Manufacturer
	CE marked product		Authorised representative in the European Community

Guidance & Declaration - Electromagnetic immunity			
The models B6, B6S, P6, P7 and P7L are intended for use in the electromagnetic environment specified below. The customer or the user of the models B6, B6S, P6, P7 and P7L should assure that it is used in such an environment.			
Immunity test	IEC 60601 test level	Compliance level	Electromagnetic environment - guidance
Conducted RF IEC 61000-4-6 Radiated RF IEC 61000-4-3	3 Vrms 150 kHz to 80 MHz 3 V/m 80 MHz to 2.5 GHz	3V 3V/m	<p>Portable and mobile RF communications equipment should be used no closer to any part of the models B6,B6S, P6, P7 and P7L, including cables, than the recommended separation distance calculated from the equation applicable to the frequency of the transmitter.</p> <p>Recommended separation distance</p> $d=1.2 \times P^{1/2}$ <p>80 MHz to 800 MHz</p> $d=2.3 \times P^{1/2}$ <p>800 MHz to 2.5 GHz</p> <p>where P is the maximum output power rating of the transmitter in watts (W) according to the transmitter manufacturer and d is the recommended separation distance in meters (m). Field strengths from fixed RF transmitters, as determined by an electromagnetic site survey, should be less than the compliance level in each frequency range.^a Interference may occur in the vicinity of equipment marked with the following symbol:</p> 
NOTE 1 At 80 MHz end 800 MHz, the higher frequency range applies.			
NOTE 2 These guidelines may not apply in all situations. Electromagnetic propagation is affected by absorption and reflection from structures, objects and people.			
<p>^a Field strengths from fixed transmitters, such as base stations for radio (cellular/cordless) telephones and land mobile radios, amateur radio, AM and FM radio broadcast and TV broadcast cannot be predicted theoretically with accuracy. To assess the electromagnetic environment due to fixed RF transmitters, an electromagnetic site survey should be considered. If the measured field strength in the location in which the models B6, B6S, P6, P7 and P7L are used exceeds the applicable RF compliance level above, the models B6, B6S, P6, P7 and P7L should be observed to verify normal operation. If abnormal performance is observed, additional measures may be necessary, such as reorienting or relocating the models B6, B6S, P6, P7 and P7L.</p> <p>^b Over the frequency range 150 kHz to 80 MHz, field strengths should be less than 3V/m.</p>			

Guidance & Declaration-electromagnetic immunity			
The models B6, B6S, P6, P7 and P7L are intended for use in the electromagnetic environment specified below. The customer or the user of the models B6, B6S, P6, P7 and P7L should assure that it is used in such an environment.			
Immunity test	IEC 60601 test level	Compliance level	Electromagnetic environment - guidance
Electrostatic discharge (ESD) IEC 61000-4-2	±6 kV contact ±8 kV air	±6 kV contact ±8 kV air	Floors should be wood, concrete or ceramic tile. If floors are covered with synthetic material, the relative humidity should be at least 30 %.
Electrical fast transient/burst IEC 61000-4-4	±2kV for power supply lines ±1 kV for Input /output lines	±2kV for power supply lines	Mains power quality should be that of a typical commercial or hospital environment.
Surge IEC 61000-4-5	±1 kV line to line ±2 kV line to earth	±1 kV line to line	Mains power quality should be that of a typical commercial or hospital environment.
Voltage dips, short interruptions and voltage variations on power supply input lines IEC 61000-4-11.	<5 % U_T (>95% dip in U_T .) for 0.5 cycle 40 % U_T (60% dip in U_T) for 5 cycles 70% U_T (30% dip in U_T) for 25 cycles <5% U_T (>95 % dip in U_T) for 5 sec	<5 % U_T (>95% dip in U_T .) for 0.5 cycle 40 % U_T (60% dip in U_T) for 5 cycles 70% U_T (30% dip in U_T) for 25 cycles <5% U_T (>95 % dip in U_T) for 5 sec	Mains power quality should be that of a typical commercial or hospital environment. If the user of the models B6, B6S, P6, P7 and P7L requires continued operation during power mains interruptions, it is recommended that the models B6, B6S, P6, P7 and P7L be powered from an uninterruptible power supply or a battery.
Power frequency (50/60 Hz) magnetic field IEC 61000-4-8	3 A/m	3 A/m	Power frequency magnetic fields should be at levels characteristic of a typical location in a typical commercial or hospital environment.
NOTE U_T is the a. c. mains voltage prior to application of the test level.			

2 Acquaintance of the product and its parts

2.1 The top and bottom map of main unit

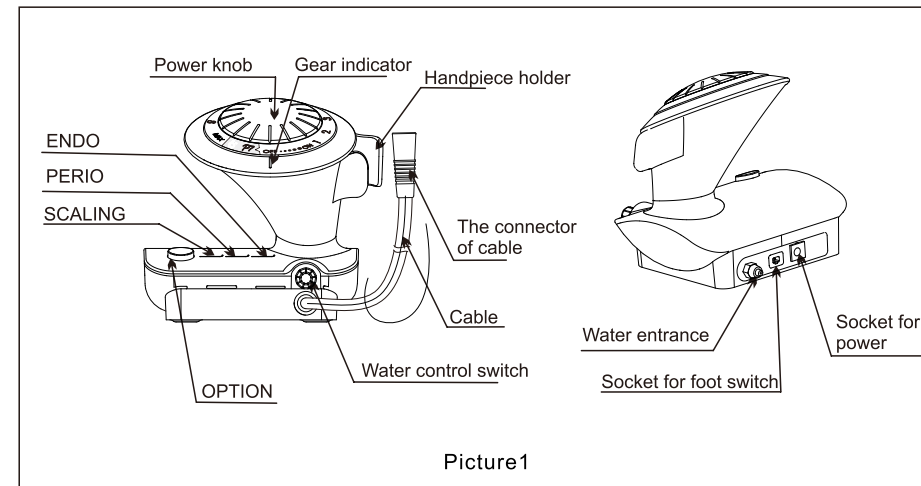

2.2 B6/B6S accessories

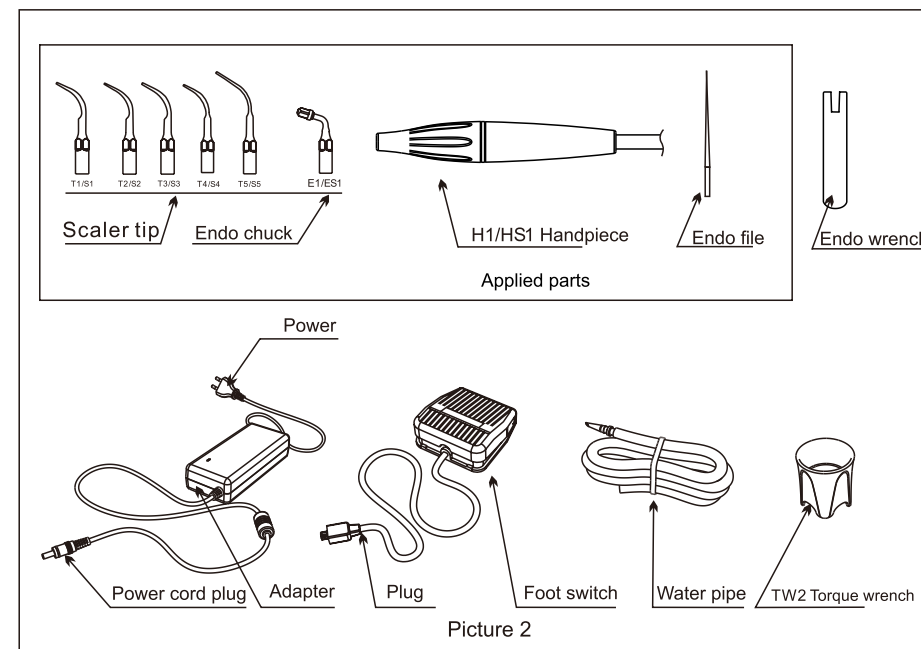

2.3 P6 accessories

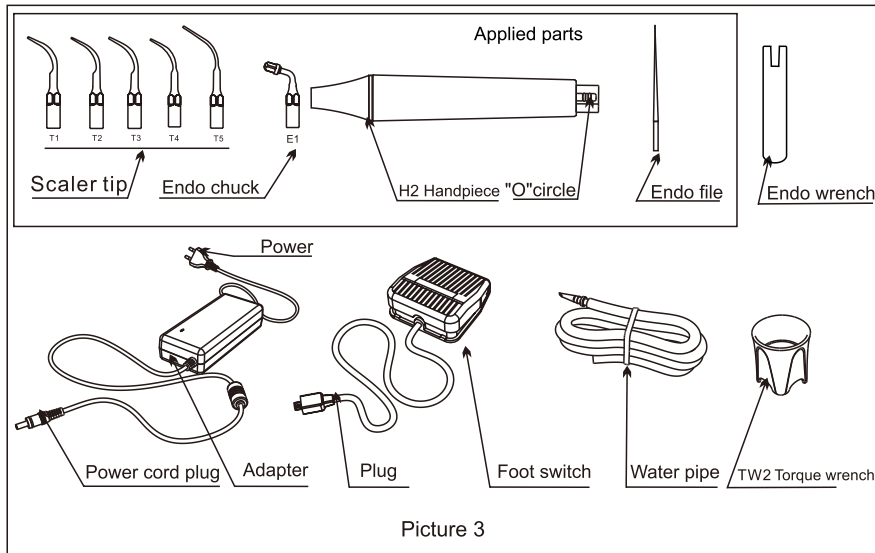

2.4 P7 accessories

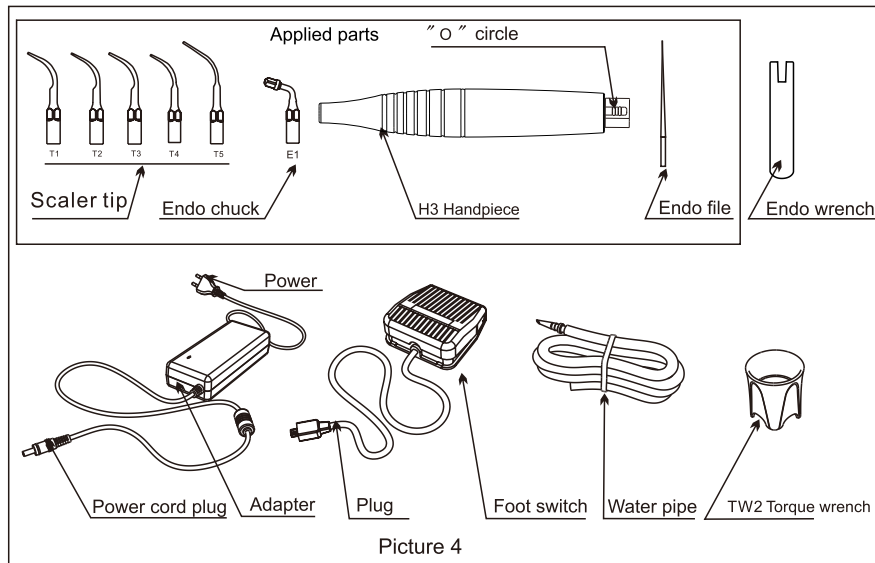

13 EMC-Declaration of conformity

Guidance and manufacturer's declaration-electromagnetic emissions		
The models B6, B6S, P6, P7 and P7L are intended for use in the electromagnetic environment specified below. The customer or the user of the models B6, B6S, P6, P7 and P7L should assure that it is used in such an environment.		
Emissions test	Compliance	Electromagnetic environment - guidance
RF emissions CISPR 11	Group 1	The models B6, B6S, P6, P7 and P7L use RF energy only for its internal function. Therefore, its RF emissions are very low and are not likely to cause any interference in nearby electronic equipment.
RF emissions CISPR 11	Class B	The models B6, B6S, P6, P7 and P7L are suitable for use in domestic establishment and in establishment directly Not connected to a low voltage power supply network which supplies buildings used for domestic purposes.
Harmonic emissions IEC 61000-3-2	Complies	
Voltage fluctuations / flicker emissions IEC 61000-3-3	Complies	

11 After-service

11.1 We offer 15 months free repair to the equipment based on warranty card from the date when it is sold to the end user. Lifetime maintenance.

11.2 The repair of the equipment should be carried out by our professional technician. Irretrievable damage caused by the nonprofessional technician, and damage accidentally or deliberately caused by operators, are out of the range of warranty.

12 Environmental protections

12.1 You can deal with it based on the local law.

12.2 We reserve the right to change the design of the equipment, product technique, accessories, instruction manual and the content of original packing at any time without notice. If there are some differences between picture and real equipment, take the real equipment as the norm.

2.5 P7L accessories

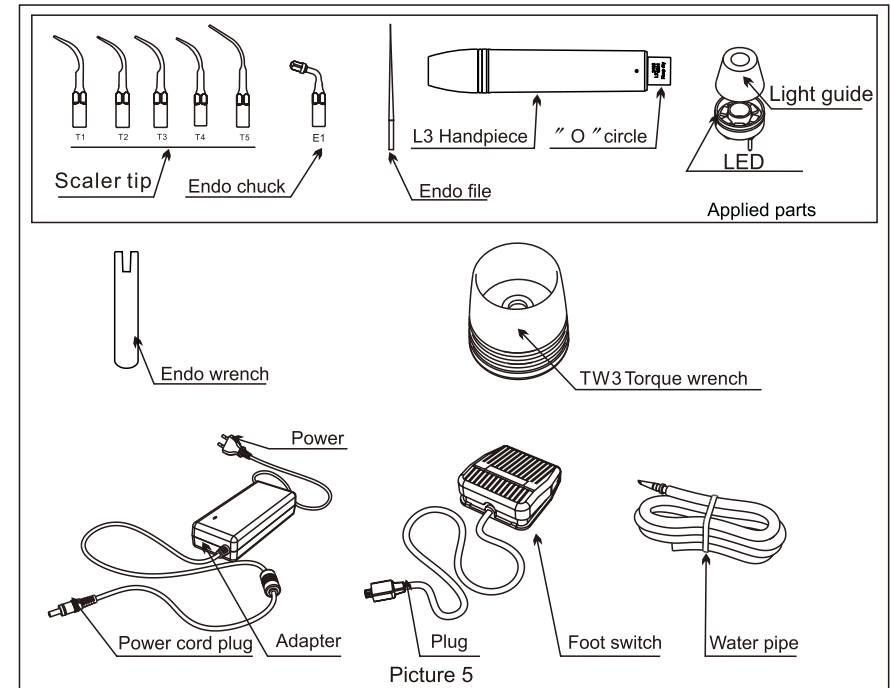

2.6 Connection sketch map

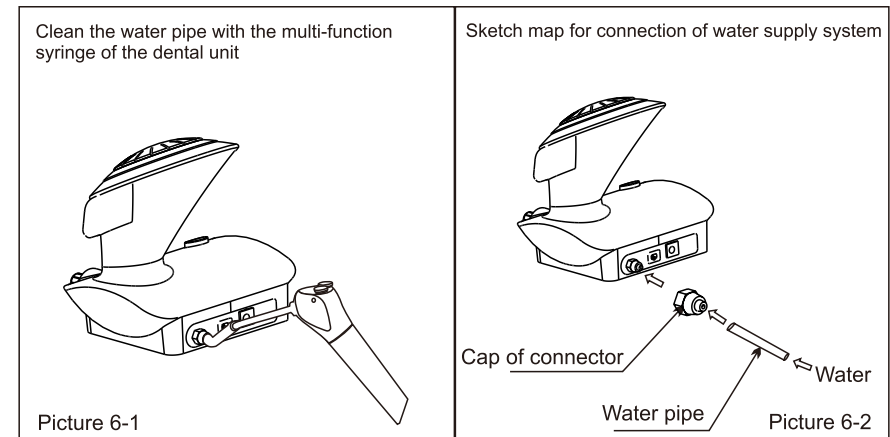

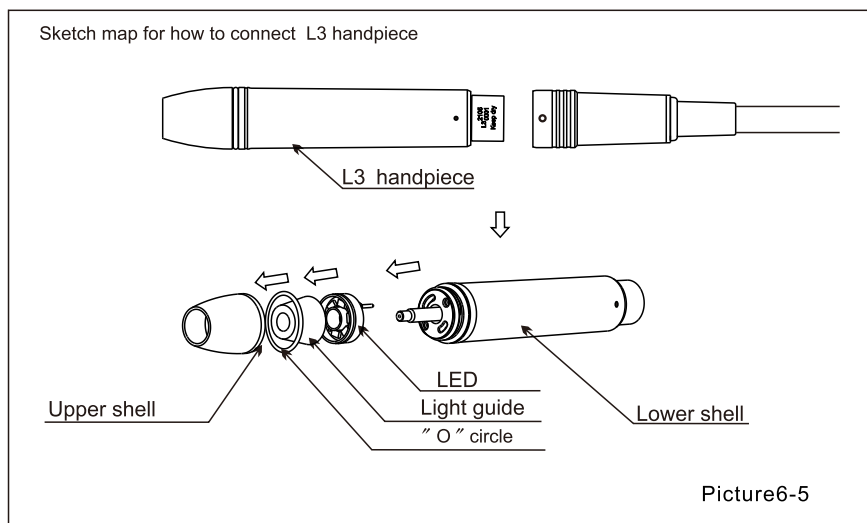
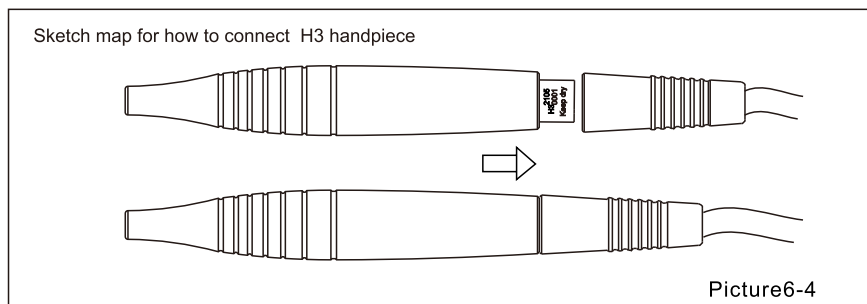
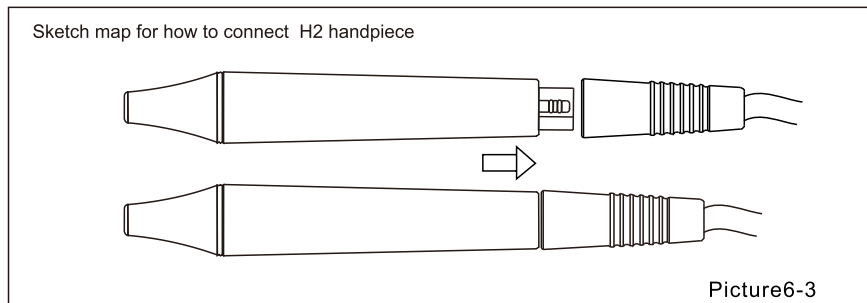

9.2 Notes

9.2.1 [Note 1] Adjust the water control switch according to the direction shown can control the water volume.

9.2.2 [Note 2] Clean the water pipe with the multi-function syringe of the dental unit (Picture 6-1)

- ① Cut the water pipe at a distance of 10cm to 20cm from the water entrance.
- ② Turn on the electricity and get through the electricity.
- ③ Connect the multi-function syringe of dental unit to water pipe.
- ④ Disassemble the tip.
- ⑤ Turn on the power and step on the foot switch to start the scaler.
- ⑥ Turn on the switch of the multi-function syringe, press the water into the machine and the impurity blocked in the water pipe can be eliminated.

9.2.3 [Note 3] If the scaler tip has been screwed tightly and there is fine spray too, the following phenomena show that the scaler tip is damaged:

- ① The vibrating intensity and the water atomization degree become weak obviously.
- ② During treatment, it produces the sound like "buzz" from the scaler tip.

9.3 If not use for a long time, please make the machine get through the electricity and water once per month for five to ten minutes.

10 Storage and transportation

10.1 Environmental conditions of storage and transportation:

- a) Relative humidity: 0 to 80%
- b) Atmospheric pressure: 50kPa to 106kPa
- c) Environmental temperature: -10℃ to +50℃

10.2 Prevent excessive shock and vibration in transportation, be sure to handle with care and avoid inversion.

10.3 Don't mix with dangerous goods during transportation.

10.4 Avoid the sun, rain or snow during transportation.

10.5 The equipment should be handled carefully and lightly. Be sure that it's far from the vibration, and install or store in a cool, dry and ventilated place.

10.6 Don't store the machine with the articles that are combustible, poisonous, caustic and explosive.

9 Maintenance

9.1 Troubleshooting and notes

Fault	Possible cause	Solutions
The scaler tip doesn't vibrate and there is no water flowing out when stepping on the switch.	The power pipe plug is in loose contact.	Make the plug insert to the socket well.
	The foot switch is in loose contact.	Insert the foot switch to its socket tightly.
	The fuse of transformer is broken.	Contact our dealers or us .
	The fuse in the main unit is broken.	Contact our dealers or us.
The scaler tip doesn't vibrate but there is water flowing out when stepping on the switch.	The tip is in loose contact.	Screw the tip on the handpiece tightly (picture 6-7).
	The connect plug between the handpiece and the circuit board is in loose contact.	Contact our dealers or us.
	Problem of handpiece.	Contact our dealers or us.
The scaler tip vibrates but there is no spray when stepping on the switch.	The water control switch is not on.	Turn on the water control switch 【note 1】 .
	There is impurity in the solenoid valve.	Contact our dealers or us.
	The water system is blocked.	Clean the water pipe by multi-function syringe 【note2】 .
	There is air in the water pipe.	Disassemble the scaler tip, and turn the water control switch to maximum. Meanwhile, make water pressure higher to 0.5MPa max.
	Water single pass is blocked	Replace water filter (picture 6-8).
There is still water flowing out after the power is off.	There is impurity in the solenoid valve.	Contact our dealers or us.
The handpiece generates heat.	The water control switch is in a low grade	Turn the water control switch to a higher grade 【note 1】 .
The amount of spouting water is too little.	The water pressure is not high enough.	Make the water pressure higher.
	The water pipe is blocked.	Clean the water pipe by multi-function syringe 【note2】 .
The vibration of the tip becomes weak.	The tip hasn't been screwed on the handpiece tightly.	Screw the tip on the handpiece tightly(picture 6-7).
	The tip is loose because of vibration.	Screw the tip tightly (picture 6-7).
	The tip is damaged.	Change a new one.
The joint of the handpiece and cable has water leakage.	"O" shape water-proof rubber circle is broken .	Change a new one.

If the problem still can't be solved, please contact with local dealer or manufacturer.

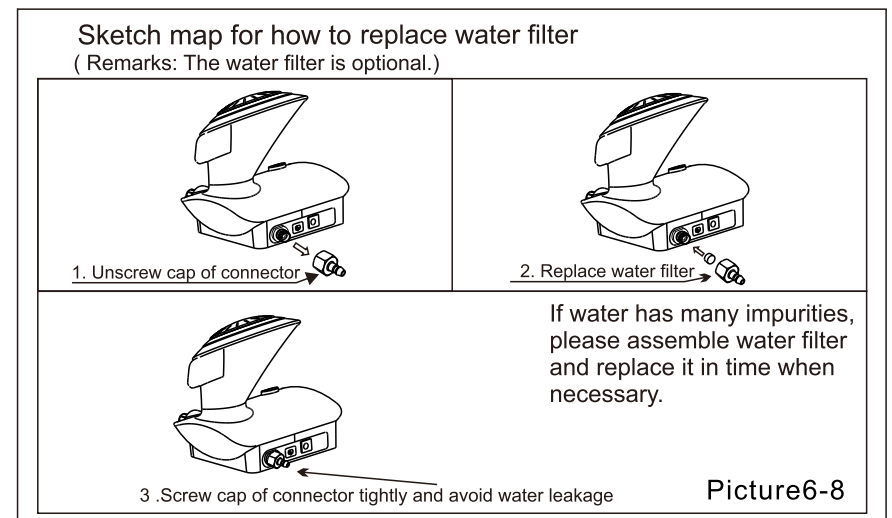
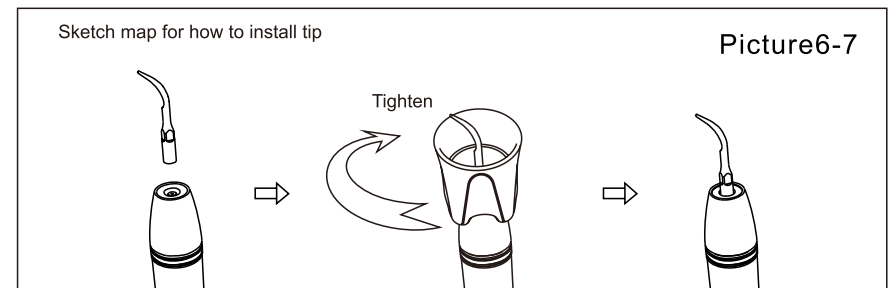
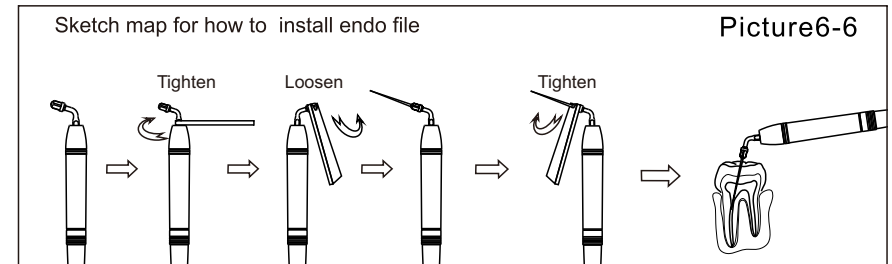

3 Product structure,scope of application and contraindication

3.1 Product performance and structure

Ultrasonic scaler is composed of electrocircuit, waterway and ultrasonic transducer.

3.2 Intended Use

A powered device utilizing a vibrating ultrasonic tip to remove calculus and other accretions from tooth surfaces during dental cleaning, periodontal therapy and root canal treatment.

3.3 Contraindication

3.3.1 The hemophilia disease patients or patients with thrombocytopenia purpura are forbidden to use this equipment.

3.3.2 The patients or doctors with heart pacemaker are forbidden to use this equipment.

3.3.3 The heart disease patients, pregnant women and children should be cautious to use the equipment.

4 Components

Number	Description	Type
01	Main unit	B6/B6S/P6/P7/P7L
02	Adapter	BL-PW-02
03	Foot switch	F1
04	Handpiece	H1/HS1/H2/H3/L3
05	Scaling tip	T1/S1
06	Scaling tip	T2/S2
07	Perio tip	T3/S3
08	Scaling tip	T4/S4
09	Scaling tip	T5/S5
10	Endo chuck	E1/ES1
11	Endo file	————
12	Wrench	TW1/TW2/TW3
13	Endo wrench	EW1
14	Water pipe	————
15	“O” circle	————
16	Instruction manual	P series
17	Qualified certificate	B6/B6S/P6/P7/P7L
18	Warranty card	B6/B6S/P6/P7/P7L
19	Packing list	B6/B6S/P6/P7/P7L

Product components are subject to the packing list.

8 Precautions

8.1 Please keep the scaler clean.

8.2 The handpiece, scaler tip, endo chuck, endo file, endo wrench and torque wrench must be sterilized before each treatment.

8.3 Don't screw or unscrew handpiece and scaler tip when stepping on the foot switch.

8.4 The scaler tip must be fastened by torque wrench and there must be fine spray coming from the tip when operating.

8.5 Change a new one when the tip is damaged or worn excessively.

8.6 Don't twist the tip or rub it.

8.7 Please use purity water source and be sure not to use normal brine instead of purity water source.

8.8 If use non-pressure water, the water should be one meter higher than the head of the patient.

8.9 When the scaler is operated, please don't pull the handpiece forcibly in case of the handpiece or handpiece cord damage.

8.10 Don't knock or rub the handpiece.

8.11 After operating, turn off power (turn the power switch to OFF), then pull out the plug, and cut off power supply.

8.12 We are only responsible for the safety of machine in the following conditions:

I. The maintenance, repair and modification are made by the manufacturer or the authorized dealer.

II. The changed components are original of “P series” and operated according to instruction manual.

8.13 Please use our T series tips for B6/P6/P7/P7L and use S series tips for B6S, if forcibly use other tips which may not match the scaler it may result in damage beyond repair.

8.14 Please use our power supply or same model power supply.

8.15 The device has been tested and homologated in accordance with EN 60601-1-2 for EMC. This does not guarantee in any way that this device will not be effected by electromagnetic interference.

Avoid using the device in high electromagnetic environment.

b) There are two "O" circles in each handpiece which need to be sterilized, plugged and unplugged repeatedly. For the purpose of extending life time, dental lubricant should be used. The circles should be replaced once they are broken or over abrasive.

7.2.2 Sterilization procedure

Operation	Operating mode	Warning
1 Cleaning and disinfection	Disassemble handpiece from detachable cable. Disassemble tip from handpiece. Wipe handpiece & scaler tip & torque wrench with medical alcohol or with special dental disinfection towel.	Cleaned in the ultrasonic bath is forbidden. Dipped in liquor is forbidden. Torrefied in oven or microwave oven is forbidden.
2 Packing	Pack handpiece & scaler tip & torque wrench in sterilization pouches.	Check the validity period of the pouch given by the manufacturer to determine the shelf life. Use packing which are resistant up to a temperature of 141°C and in accordance with EN ISO 11607.
3 Sterilization	Steam sterilization at: 135°C and 0.22MPa during 3 min.	Use fractionated vacuum autoclaves (according to EN 13060, EN 285). Use validated sterilization procedure according to EN ISO 17665-1. Respect maintenance procedure of the autoclave device given by the manufacturer. Use only the listed sterilization procedures.
4 Storage	Keep handpiece & scaler tip & torque wrench in sterilization packing in a dry and clean environment.	Sterility cannot be guaranteed if packing is open, damaged or wet (check the packing before using the instruments).

5 Technical specifications

5.1 Performance technical specifications

Adapter Input	100 - 240V~ 50/60Hz 0.7A - 0.4A
Main unit input	30V == 1.2A
Main unit fuse	250V/T 1.6AL
Output power	3W - 20W
Output primary tip vibration excursion	≤ 200 μm
Output tip vibration frequency	28kHz ± 3kHz
Output half-excursion force	< 2N
Water pressure	0.1MPa~0.5MPa(1bar~5bar)
Weight of main unit	0.65kg
Weight of adapter	0.34kg
Operating mode	Continuous operation
Classification 93/42/EEC	Class IIa
Electric shock protection type	Class II
Degree of protection against electric shock	B
Degree of protection against harmful ingress of water	Ordinary equipment (IPX0), Foot switch(IPX1)
Degree of safety of application in the presence of a Flammable Anesthetic Mixture with air or with Oxygen or Nitrous Oxide	Equipment not suitable for being used in the presence of a flammable anesthetic mixture with air or with oxygen or nitrous oxide.

5.2 The conditions of working environment:

5.2.1 Environmental temperature: +10°C to +40°C

5.2.2 Environmental humidity: 0 to 80%

5.2.3 Atmospheric pressure: 700hPa to 1060hPa

6 Usage

6.1 Open the packing, make sure that all the parts and accessories are complete according to the packing list. Take the main unit out of the box and put it on a stable plane.

6.2 Turn the water control switch to the max based on symbol as shown in 9.2.1[Note 1].

6.3 Insert the plug of the foot switch to its socket.

6.4 Connect one end of the water pipe to the water entrance, lock the water pipe tightly with locknut, and connect the other end to the pure water source.

6.5 Connect the handpiece with the cable(Picture 6-3,6-4,6-5), select a suitable scaler tip as you need and screw it on the handpiece tightly by the torque wrench (Picture 6-7).

6.6 Turn off the main unit power, then insert the plug of the power source, and then get through to the power.

6.7 Turn on the power button, and start the machine.

6.8 Press the function button to choose scaling, periodontal or endo mode.

6.8.1 Scaling function.

- a) After start the machine, the default initial state is scaling function, and SCALING indicator lights.
- b) Vibration intensity: Adjust the vibration according to the requirement. Generally adjust to 3 to 4 grade, but also adjust vibration intensity according to the patient's sensitivity and hardness of dental calculus at any time during the clinical treatment.
- c) Water volume adjustment: Step on the foot switch and the tip vibrates, and then turn the water control switch to form fine spray to cool handpiece and clean teeth.
- d) Generally, hold the handpiece in the gesture as a pen in hand.
- e) In clinical treatment, don't use the point of tip to contact with the teeth vertically, so as not to damage teeth and tip.
- f) The normal frequency is extremely high. Under the normal working state of scaler tips, a light touch and a certain to-and-fro motion will eliminate the tartar without heating. Overexertion and long-time lingering are forbidden.

6.8.2 Periodontal function

- a) Press "OPTION" button, switch to periodontal function, then PERIO mode indicator lights.
- b) After switching to periodontal function, select the right tips, and use torque wrench to fix it on the handpiece.
- c) Adjust the frequency based on current status, it can be periodontal scaling after adjusting the right frequency.

6.8.3 Endo function (Picture 6-6)

- a) Press "OPTION" button, switch to endo function, and ENDO indicator lights.
- b) Use endo wrench to fix endo chuck to handpiece. (Picture 6-6)
- c) Loosen the nut of endo chuck.
- d) Insert endo file in the front hole of the endo chuck and use endo wrench to tighten the nut so as to clamp the file.
- e) Put the endo file into patient's root canal slowly, start the foot switch can conduct ultrasonic root canal therapy. During clinical treatment, adjust the frequency according to actual situation.

Note: Must put the endo file into root canal before starting the foot switch.

6.9 After finishing operation, keep the machines working for 20-30 seconds on the water supply condition in order to clean the handpiece and tips.

6.10 Uninstall the tip, sterilize handpiece, tips, endo chuck ,endo file and torque wrench.

Note: Please don't pull out the handpiece and tips when the foot switch is stepped on and the machine is producing ultrasonic vibration.

7 Sterilization

7.1 Sterilizing sealed handpiece

Handpiece can be sterilized by any neutral sterilized liquid for cleaning and sterilizing. Do not sterilize in the high temperature and pressure.

7.2 Sterilizing detachable handpiece

7.2.1 Precautions

- a) Please pay attention to the handpiece during the process of operation and sterilization to see whether it is externally broken. No protective oil is allowed to be painted on the handpiece.