

NICE TOUCH

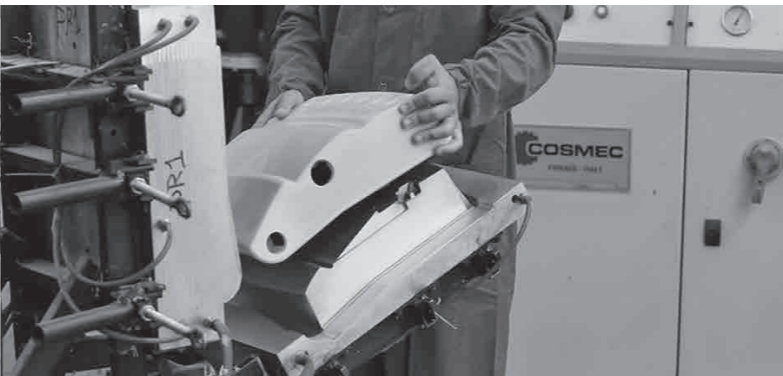

A CONCENTRATE OF TECHNOLOGY  
FOR HIGH-LEVEL PERFORMANCE.

**miglionico**  
DENTAL EQUIPMENT



## MIGLIONICO, AN ALL ITALIAN STORY.

WE CAREFULLY SELECT THE BEST  
RAW MATERIALS AND TRANSFORM  
THEM TO CREATE OUR UNITS.  
WE WORK WITH PASSION AND  
COMMITMENT TO GUARANTEE  
QUALITY AND RELIABILITY OVER  
TIME.

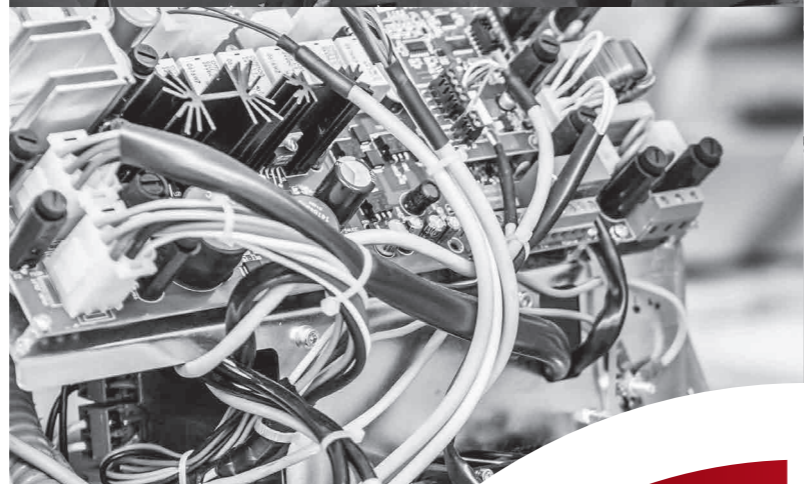

### Internal production

Our highly specialized staff, through the use of the most innovative software and mechanical technologies, create the units from the design to the quality control. We have CAD / CAM machines, laser cutting machines, press bending machines, numerical control lathes, polyurethane molding devices and welding devices. The internal and direct management of the entire production allows us to offer excellent products while remaining very competitive and versatile.



### High quality materials

The key to quality lies in the choice of excellent materials. We combine innovation and solidity to guarantee reliable and resistant products. We only use excellent materials, such as aluminum and iron for the internal structure, painted polyurethane for external surfaces, glass for the display pannels and skay leather for the upholstery. Our goal is to offer you a solid product, easy to manage and sanitize, to make our units last over time.





**NICE TOUCH**

A CONCENTRATE OF TECHNOLOGY  
FOR HIGH-LEVEL PERFORMANCE.  
COMPLETE CONTROL, INTUITIVE USE.





## OPERATOR SIDE

### Giving space to your needs

The operator side is designed to guarantee maximum ergonomics and ease of handling. The arm has a wide excursion that allows you to position the operator console in the most functional working position, while still maintaining its reduced dimensions. The console, designed to accommodate up to 6 instruments, is equipped with an automatic sensor activation when each handpiece is withdrawn from its position and a removable and autoclavable silicone instrument mat.

### Your world in color

Thanks to the new 7 inch glass surface color display, managing the unit is even easier. The display is encapsulated in a painted polyurethane structure, with an articulated joint, to be able to be positioned based on the operator's viewing angle. The wide display surface is in glass, and is bright and easy to sanitize. The touch technology allows the unit to be managed with extreme ease and immediacy, moving easily between all the present features and settings.

Extendable hoses up to 96cm which are self-balancing and without traction in the SPRIDO (top delivery) version.

Operator console in polyurethane and pre-disposed to accommodate 6 instruments

Stainless steel tray holder which has a 360° rotation. Available in three sizes



Self-balanced arm

Low delivery arm to reduce the overall dimensions and facilitate the movement of the instruments

Ergonomic handles thanks to two different mounting options, removable and autoclavable

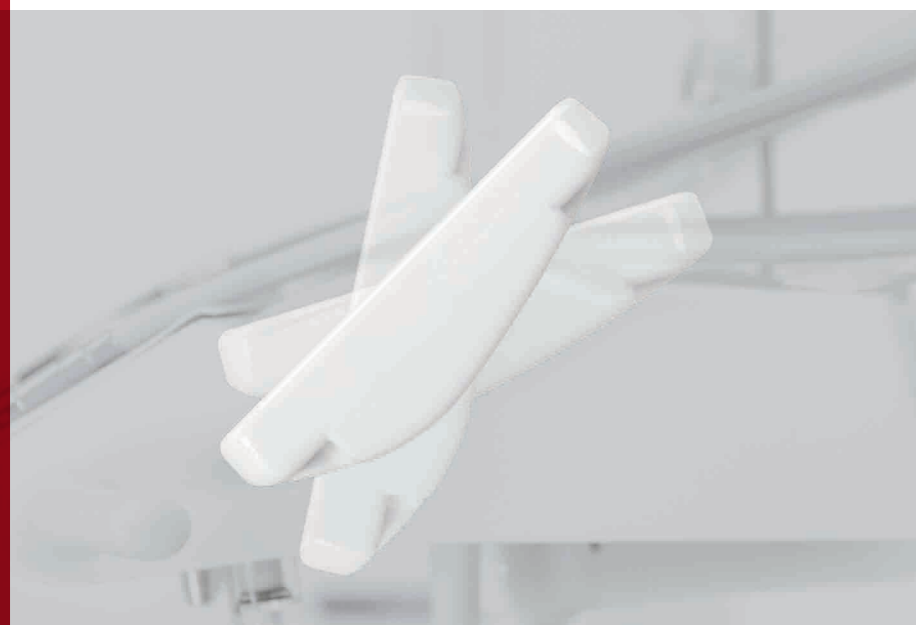



## Touch display: Everything under control

INNOVATIVE, INTUITIVE AND FUNCTIONAL, it guarantees optimal content management thanks to the countless possibilities for customization.

The large screen and the essential graphics permit management, in the same screen, of both the parameters of the instrument as well as all the functions and movements of the unit in a simple and fast manner, optimizing the operational time and operator and patient safety.

## Endodony base

The standard MCX Bien Air micromotor allows operation both in the restorative and the endodontic mode.

In both cases it is possible to set the specific parameters of the instrument such as, for example, choosing the ratio of the handpiece used, the number of actual rpms, the inversion of the rpms, the peristaltic pump flow activation, the on / off spray and led to instruments. In the ENDODONTIC mode it is also possible to adjust the torque and set auto reverse / auto stop / auto forward with reverse time adjustment. With auto forward activated you can use the CRUISE CONTROL function, which allows you to keep the micromotor active without having to use the pedal. From the same screen it is possible to store the settings chosen in one of the 10 customized programs

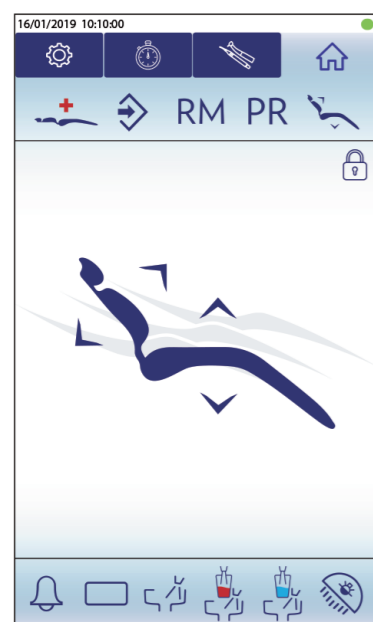

From the HOME and from the INSTRUMENTS screens it is possible to move the chair, memorize and recall the positions, manage the water to the cuspidor and to the glass, activate the X-Ray film viewer and the operator lamp. The screen lock function allows easy and safe sanitization of the display.



The SETTINGS menu allows you to choose among 5 user profiles and to set the timers. All user parameters are automatically recalled by accessing the selected profile. It is also possible to choose different languages settings.

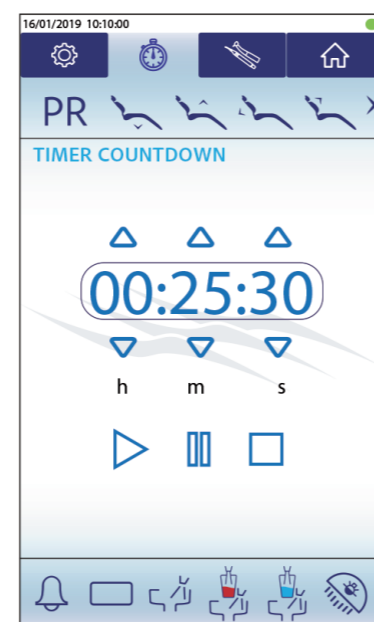

In the COUNTDOWN folder you can set the stopwatch which will activate a countdown. When the instruments are withdrawn, the countdown will continue and will be visible on the top bar instead of on the stopwatch icon. At the end of the timer, the device will emit a warning sound.

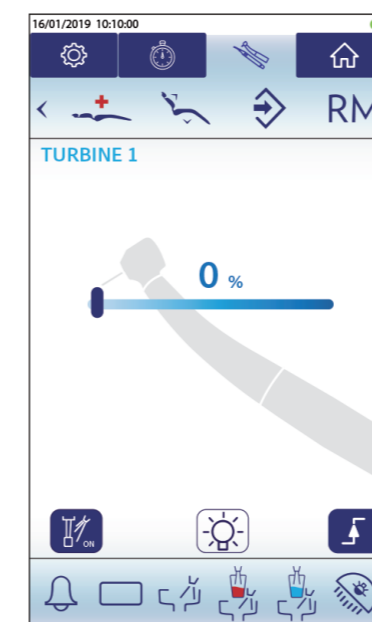

The setting of the instrument parameters is extremely simplified thanks to the dedicated tab which allows the total management of the instrument even when it is not withdrawn. Switching from one instrument to another is quick and easy thanks to the swipe system for scrolling through the screens.

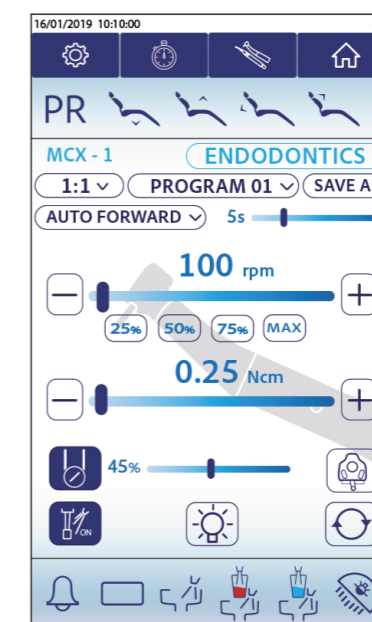

The instrument parameters can be set using the + and - keys or by dragging the cursor on the bar or again using the shortcut keys. It is possible to manage the spray and LED on / off instrument icons.

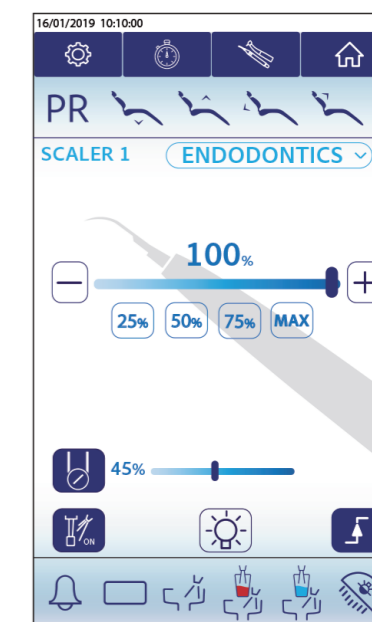

With the dedicated scaler it is possible to:

- Operate in : Endo, Scaling, Perio mode
- Manage the flow of the peristaltic pump
- Activate proportional mode













## Only excellence is chosen

The operator's delivery console pre-disposed for 6 instruments can be customized according to the needs of the operator. All the modules are created in partnership with the main manufacturers of handpieces in the sector to guarantee reliability and technology. The best partners for the best products to offer you.

### INSTRUMENTS

 MCX BIEN AIR BRUSHLESS MICROMOTOR	 LUZZANI STAINLESS STEEL SYRINGE	 F.O MIDWEST TURBINE OUTLET	 SATALEC /TKD CURING LIGHT	 SATALEC/EMS/ MIGLIONICO SCALER
 INTRAORAL CAMERA	 SECOND BRUSHLESS MICROMOTOR	 SECOND F.O MIDWEST TURBINE OUTLET	 STERIJOUNT SATELEC	

## Surgery Package



MX2 BIEN AIR MICROMOTOR



SATELEC PERISTALTIC PUMP



SPECIFIC PROGRAM

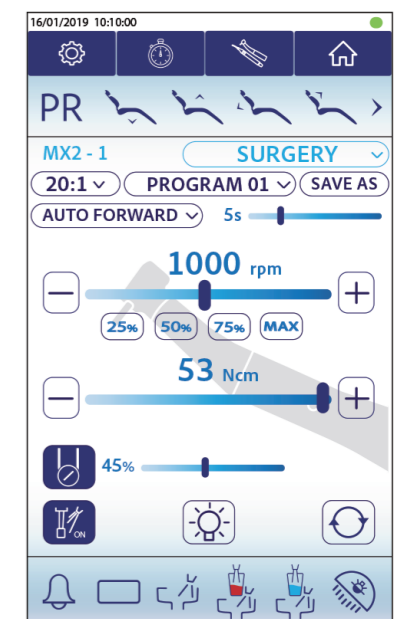
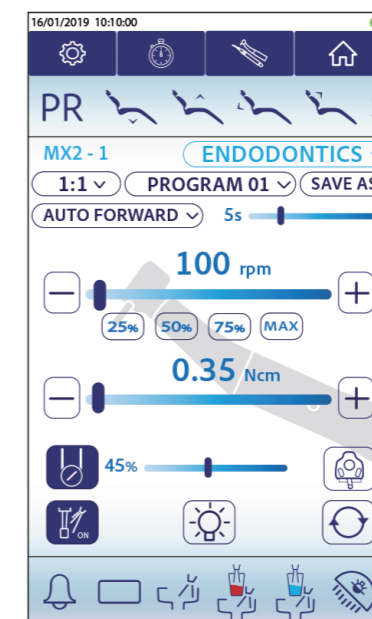
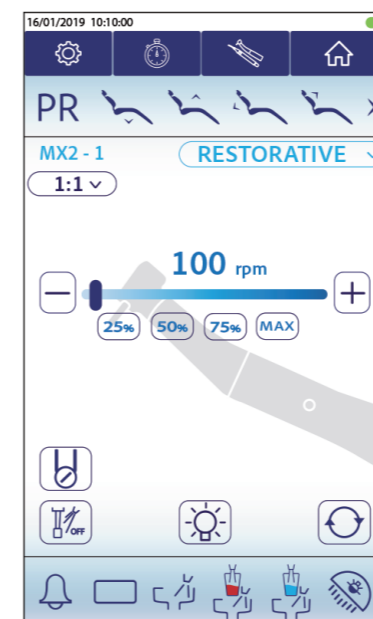

The surgery package contains all the instruments necessary to operate safely and accurately:

- the Bien Air MX2 surgical micromotor with specific program to set, customize and monitor the parameters necessary for restorative interventions, endodontics and surgery.
- The peristaltic pump for external irrigation with flow regulation during surgery.
- The sterijoint for external irrigation on the scaler with peristaltic pump.



NICE TOUCH





Movement is freedom

The assistant delivery arm is mounted on a double articulation arm which allows to better manage the work area whether working alone or with an assistant. The possibility of maneuvering the space near the patient and the hydro group, using the convenient handle placed on the delivery arm, allows ample freedom in the movements and in patient assistance procedures. The comfort of the patient in the rinsing phase is in perfect harmony with that of the assistant during work thanks to the cuspidor with 180° rotation. Easy to handle, it is also removable. As an option it is possible to request the pantographed arm which adds to the horizontal and vertical excursion.



The perfect ally

The assistant display console is made of glass with capacitive touch technology: the command keys allow you to manage the unit's functions with a simple touch. All the instruments are activated automatically and placed on removable and autoclavable supports. The hydro unit is compact and functional thanks to the facilitated movements of both the cuspidor and the upper carter.

Hydro group

Designed to simplify routine maintenance as much as possible, the Nice Glass hydro unit is equipped with a practical slide opening. Simply just rotate the cover to have easy access to the hydro and electronic components, properly separated to guarantee safety and comfort. The technological heart of the unit, it is enclosed in a compact and functional space.

INSTRUMENT CONFIGURATION

STANDARD



SUCTION CANNULAS



OPTIONAL



STAINLESS STEEL SYRINGE



CURING LIGHT



Commands and configuration

The assistant console, intuitive and multi-functional, allows chair movement, activation and timing of hot or cold water to the glass, rinse to cuspidor management, On / Off of the operator lamp and recall of positions. The standard console houses two suction cannulas. It is possible to add an extra two housing for curing light and syringe.





NICE TOUCH



## Syncro CHAIR

Padded with a soft comfort system and covered in seamless skay eco-leather. The chair has a wide range of operational movements and thanks to the independent and synchronized movement of the back, seat and footrest, it guarantees extreme flexibility. The chair is equipped with 4 anti-crush safety systems.

\*Additional colors available upon request.

 COD. 920 RENOIR	 COD. 902 GIOTTO	 COD. 904 KOSTABI	 COD. 905 GAUDI	 COD. 906 KLIMT	 COD. 919 BOTTICELLI
 COD. 909 MATISSE	 COD. 908 VAN GOGH	 COD. 950 BOTERO	 COD. 923 MODIGLIANI	 COD. 924 MIRÒ	 COD. 910 RAFFAELLO
 COD. 914 CARAVAGGIO	 COD. 922 DALÌ	 COD. 915 LEONARDO	 COD. 911 MICHELANGELO	 COD. 6001 DEGAS	 COD. 8017 MONET

Additional colors available upon request.

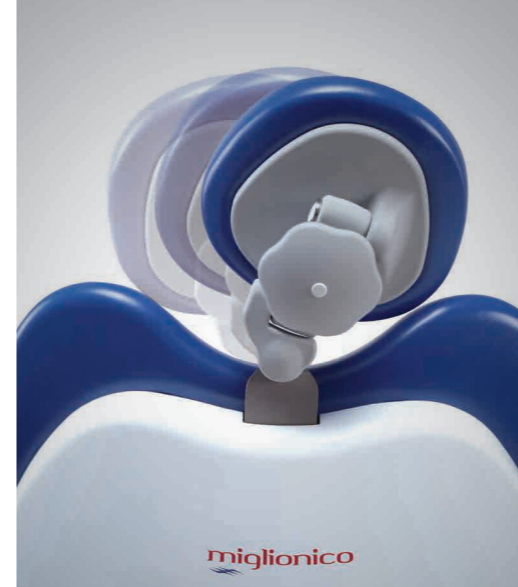

### HEADREST

Adjustable in height and adjustable on three axes, in skay leather.



### ARMREST

The unit is equipped with the comfortable and functional rubber armrest on the left.



### WIDE BACKREST

Ideal for those who love working in the 12:00 o'clock position.



### SLIM BACKREST

Ideal for those who love working in the 9:00 o'clock position or standing.



### SEAT PROTECTION PILLOW

Practical and discreet, coordinated with the upholstery, it prevents wear and tear by protecting the leather of the seat.



### CHILD REDUCTION PILLOW

Greater comfort even for the little ones. The pillow raises the seat making operation easier.

## THE BEAUTY OF COMFORT

### The details

Small details to improve quality of your work.

### The backrests

Ergonomic backrest with lumbar support and depressions designed to guarantee patient comfort and adaptability.

### The Accessories

Protect your dental unit and make it more comfortable for pedodontic patients





VERSATILITY AND ERGONOMICS

SPRIDO  
(TOP DELIVERY)  
CONFIGURATION



HANGING HOSES  
CONFIGURATION



LEFT-HANDED  
CONFIGURATION



DENTAL UNIT  
+ CART  
CONFIGURATION



According  
to your style

6 configurations  
designed  
to adapt to different  
work ergonomics.

CART STAND ALONE  
CONFIGURATION



SURGERY ROOM  
CONFIGURATION



Optimize  
your spaces

Reduced dimensions and large movements make our dental unit extremely comfortable to use both alone as well as with an assistant.

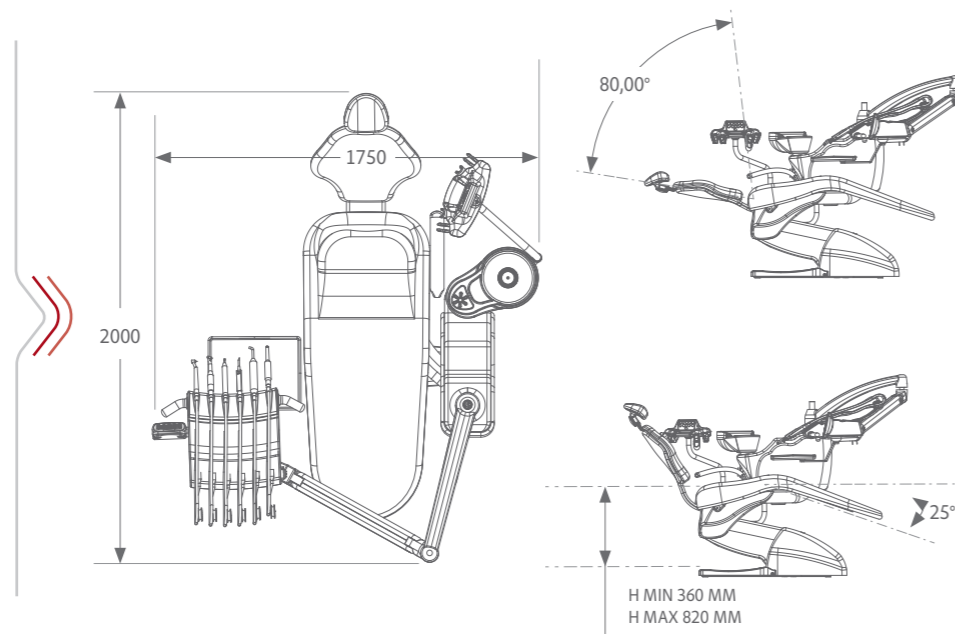

**Multimedia Kit**

Technology is a valid assistant. Whatever your needs in multimedia, there is a configurable solution. We can offer flexible and customized solutions for integrated multimedia systems.



**Operating Lamp**

For our lamps, a partner of excellence, choose between the halogen or LED technology, which Faro lamp best suits you.



**EDI**  
Halogen



**MAIA**  
Led 35000 Lux



**ALYA/THEIA TECH**  
Led 50000 Lux

**Multifunction foot pedal**

A valid ally to manage your unit. Two types of pedals are available: standard and push. Both versions can be Wi-Fi (optional).



**STANDARD**



**PUSH**



**Stools**

Your comfort first and foremost. Stools with anatomic cushions without stitching and in sky leather, with height adjustment and self-braking wheels. Available in four models.



**Removable and autoclavable parts**

Procedures for disinfection must be simple, fast and effective. Miglionico units are designed to optimize time and guarantee a constant and effective hygiene of the unit.



SILICONE MAT

QUICK RELEASE OPERATOR CONSOLE HANDLES

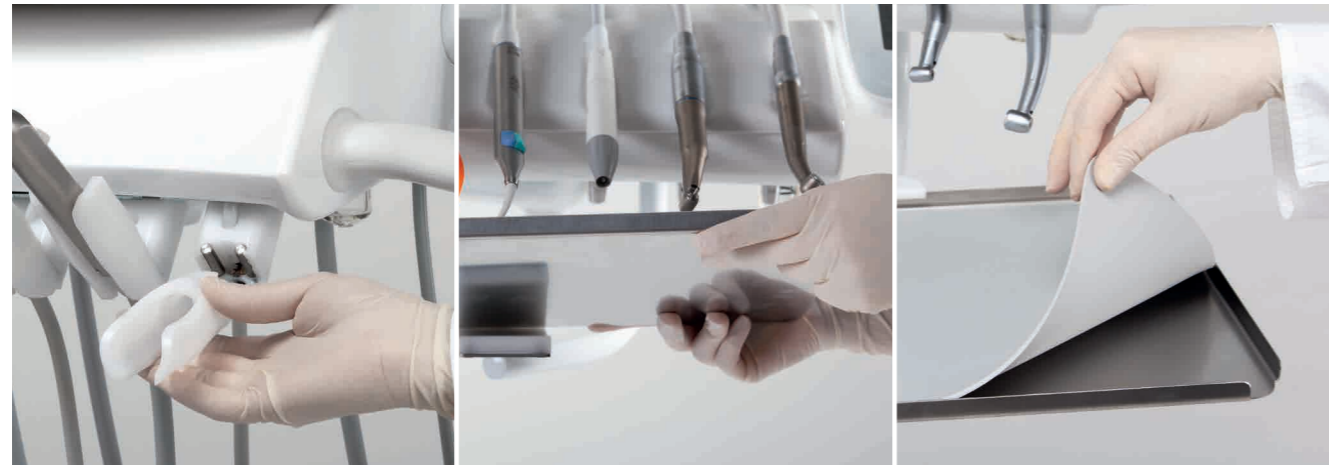

INSTRUMENT SUPPORT IN RESIN

STAINLESS STEEL TRAY HOLDER

SILICONE TRAY MAT

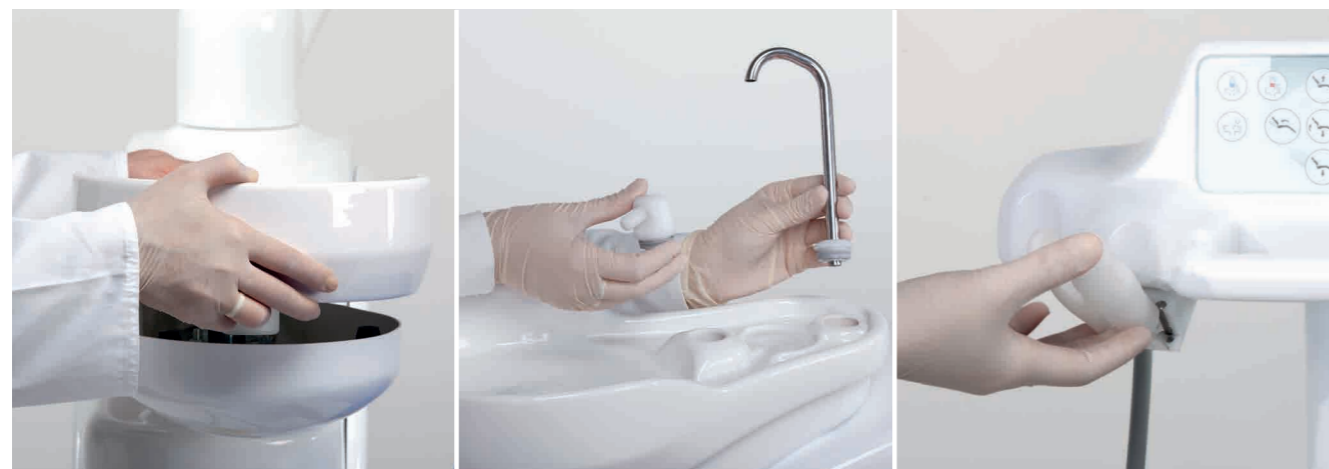

CUSPIDOR\*

WATER DISPENSERS IN RESIN AND STAINLESS STEEL

INSTRUMENT SUPPORTS ON ASSISTANT CONSOLE

\* Not autoclavable

**HYGIENE ABOVE ALL**

**Active hygiene systems**

Choose from the various standard and optional solutions the one best suited to safely support your work.

**STANDARD**



ANTI-FLUID RETRACTION SYSTEM ON THE HANDPIECES



SECURE AIRFLOW SYSTEM OF THE HANDPIECES

**OPTIONAL**



AUTOMATIC DISINFECTION SYSTEM FOR HYDRO CIRCUITS TO HANDPIECES (MDS) AND INTENSIVE DISINFECTION SYSTEM FOR HYDRO CIRCUITS TO HANDPIECES (MDS+)



PERISTALTIC PUMP SYSTEM FOR EXTERNAL IRRIGATION



INDEPENDENT WATER SUPPLY SYSTEM BY SEPARATE BOTTLE INSIDE THE UNIT + BYPASS

**INTEGRATED SUCTION SYSTEMS**

**WET SUCTION**

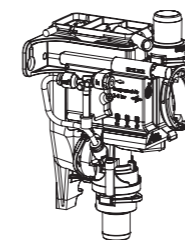

DRAIN CUSPIDOR VALVE

To be connected to the suction motor with integrated separator.

**DRY SUCTION**

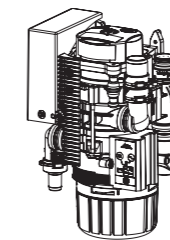

AMALGAM SEPARATOR

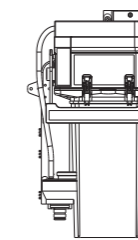

AIR / WATER SEPARATOR

**Adaptability to all suction systems**

Standard predisposition for Wet suction system and flexibility of the unit to accommodate in built devices in case of Dry suction and to be in compliance with the European Amalgam separation regulation.

# miglionico

DENTAL EQUIPMENT



**MIGLIONICO s.r.l.**  
Acquaviva delle Fonti (BA) - Italy  
Phone (+39) 080 759552  
Info@miglionico.net

To discover our product range  
and all our accessories,  
visit our website  
[www.miglionico.eu](http://www.miglionico.eu)

