



# IDI Product Catalog

Intuitive by design



idi  
Image Diagnostics Inc.



# Table of Contents

## Imaging Tables and options

Aspect ISR G3 Table	3-6
Aspect 100-4T G3 Table	7-10
Aspect 100-4 Table	11-13
Aspect 100RTL Table	14-17
Aspect 100RT Table	18-21
Aspect 100T Table	22-25
Aspect 100E Table	26-28
Aspect 100UC <i>Plus</i> Urology Table	29-33
Aspect 100US Gyn Table	34-35

## Video Integration Systems and options

MDS	36-39
ilex55	40-41
ilex 32 4K	42
ilex 32	43
ilex C	44
Connexus Direct	45

## SIMEON O.R. Lighting Systems

SIMEON Sim. LED 4500	46
SIMEON Highline & Businessline O.R. Lighting Systems	47

## Comparison Matrices

Aspect Four-Way Float Top Tables Specifications & Accessory Matrix	48
Aspect Urology & GYN Table Specifications & Accessory Matrix	49
Aspect Pain Management Table Specifications & Accessory Matrix	50

## Customer Service

IDI Customer Service Contacts	Back page
-------------------------------	-----------

For product warranties, please request document D000-2069 from an IDI representative.  
Extended warranties are available.

## Aspect ISR G3 Table



### Aspect ISR G3 Table Description:

Mobile Imaging Table with Motorized Elevation, Trendelenburg Tilt, Iso Roll and Manual 4-way Table-top Float. For Advanced Vascular Surgery and Interventional Procedures.

### Aspect ISR G3 #A100-2603 (U.S. accessory rails )

#### #A100-2834 (Metric accessory rails)

For Advanced Vascular Procedures; Includes short, recessed side rails 5" (12,7 cm) in length at imaging end of table that facilitate use of removable headrest extension (option) and also facilitates attachment of catheter tray extension at narrow end of table. Two separate catheter tray extensions are available: One for the pedestal end of table and one for the imaging end of table. Up to 5 day battery backup pack, 600 lbs (272 kgs) patient load, steer assist caster, 3.75" (9,5 cm) tongue height, 32" (81,3 cm) longitudinal tabletop float, and 33" to 45" (83,8 cm - 114,3 cm) table-top elevation.

Includes the following:

- A100-2170 Pendant hand control
- X100-2492: Tabletop 22"/56 cm - 24"/ 61 cm W x 84"/ 213 cm L
- X100-2310 Tabletop Pad, 2" (5,1 cm) thick
- A270-0163: Panning hand control
- C000-0328: Patient restraint straps







### Aspect ISR G3 Basic Vascular Package # A100-2700 (Optional package)

1. A100-2322 Tabletop Catheter Tray Extension: 22" (56 cm) Wide. Mounts to imaging end of table only.
2. A100-1007 Clamp-on accessory rail: 6" (15,2 cm) x 1.25" (3,2 cm) rail, for 100-4T and ISR tables
3. A310-056 Arm board: quick-release, rail mounted, includes pad and strap.
4. A100-2244 VAB Arm board: carbon fiber, one-piece, extra wide and rigid arm board for fistula and upper peripheral vascular procedures.
5. C000-1181 IDI Medical Grade Anti-Fatigue Mat 24" (61 cm) x 66" (168 cm) x 3/4" (1,9 cm) thick for maximum comfort & support.
6. A610-051 Radiation Shield: Articulating, rail mounted bilateral lead shield . Attaches to table side-rail at base end of table, either side, adjustable.



## Aspect ISR G3 Table Optional and Replacement Accessories:

Photo	Description <span style="color: red;">Red text = Metric accessory rails</span>	Catalog Number
	<p><b>Clamp-on Accessory Rail</b> Rail is 8 ½" long x ¾" thick x 1-1/8" high.</p> <p><span style="color: red;"><b>Clamp-on Accessory Rail</b></span> <span style="color: red;">10 mm x 25 mm x 216 mm clamp-on accessory rail.</span></p>	<p>A100-1007</p> <p><span style="color: red;">A100-2379</span></p>
	<p><b>Armboard</b> Quick-release, rail mounted (requires Clamp-on Accessory Rail A100-1007 or A100-2379 above) unless used on a table with built-in accessory rails.</p>	<p>A310-056</p> <p><span style="color: red;">A310-062</span></p>
	<p><b>VAB Armboard</b> Carbon fiber, one-piece, extra wide armboard for vascular access procedures (body section slides under patient / table pad). Includes strap and pad.</p>	<p>A100-2244</p>
	<p><b>Arm Board</b> Carbon fiber, shoulder mount (attaches by sliding thin section under patient/table pad), flat. Includes pad and strap.</p>	<p>A310-059</p>
	<p><b>Headrest Extension</b> Articulating carbon fiber headrest. Attaches to head end of ISR G3 table. Includes built in Anesthesia Screen Holder sockets. 23-½" / 58,7 cm wide x 12" / 30,5 cm long.</p>	<p>A100-2317</p> <p><span style="color: red;">A100-2505</span></p>
	<p><b>Peripheral Extension</b> Requires the table to have an X100-2492 style tabletop.</p>	<p>A100-2486</p>
	<p><b>Tabletop Catheter Tray Extension</b> 24.25" / 61,6 cm wide, 30" / 76,2 cm long. Mounts to pedestal end of table only. The maximum weight this extension can support is 20 Lbs (9 Kgs).</p>	<p>A100-1769</p>
	<p><b>Tabletop Catheter Tray Extension</b> 20 ¾" / 52,7 cm x 27" / 68,6 cm long. Mounts to imaging end of table only. Requires tabletop X100-2492. The maximum weight this extension can support is 20 Lbs (9 Kgs).</p>	<p>A100-2322</p>
	<p><b>Radiation Shield</b> Articulating, rail-mounted. Attaches to table side-rail at base end of table, bi-lateral, adjustable. Articulating joint allows shield to conform to table contour. Snap-on upper section above level of tabletop is removable.</p>	<p>A610-051</p> <p><span style="color: red;">A610-106</span></p>

## Aspect ISR G3 Table Optional and Replacement Accessories:

Photo	Description <span style="color: red;">Red text = Metric accessory rails</span>	Catalog Number
	<p><b>Anesthesia Screen Holder</b> Flexible "hoop" style. Mounts directly to A100-2317 Headrest Extension. For use on accessory rails - a pair of rotating side rail clamps, part number C000-0746, are required. Rotating side rail clamps and clamp-on accessory rails are not required if table is ordered with the A100-2317 Headrest Extension.</p>	C000-0965
	<p><b>Pendant Hand Control</b> For Aspect ISR. Controls elevate and tilt functions only (Included with table).</p>	A100-2170
	<p><b>Panning Hand Control</b> For Aspect ISR G3. (Included with table).</p>	A270-0163 <span style="color: red;">A270-0178</span>
	<p><b>ISR Table Foot Switch with Safety Hood.</b> Foot control for Aspect ISR G3 table. Foot control motions are: iso-roll, transverse travel, elevate/lower and Trendelenburg down/up. (Safety hood helps avoid accidental motorized table movement from foot switch).</p>	A100-2071
	<p><b>Heavy Duty Medical Grade Anti-Fatigue Mat</b> (24" (61 cm) x 66" (167,6 cm) x 3/4" (1,9 cm) IDI heavy-duty anti-fatigue mat. One-piece construction for high-traffic areas. Safe &amp; non-toxic, contains no plasticizers and will not leach over time. Durable brushed texture.</p>	C000-1181
	<p>Rotating, with socket for attachment of accessories with 5/8 inch (1,6 cm) circular post.</p>	C000-0746 <span style="color: red;">C000-1065</span>

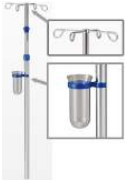
## Aspect ISR G3 Table Optional and Replacement Accessories:

Photo	Description <span style="color: red;">Red text = Metric accessory rails</span>	Catalog Number
	<p><b>IV Pole</b> Stainless steel with four bottle hooks Range: 1070 - 1660 mm Tube diameter: 25 / 18 mm</p> <p><b>IV Pole Clamp C000-1325 is required</b></p>	C000-1324
	<p><b>IV Pole Clamp</b> Aluminum. 25 mm pole opening</p>	C000-1325

## Shipping Crate Specifications

- Weight (approx.): 750 lbs. (340kg)
- Length: 96" (2,4 m).
- Width: 42" (1,1 m).
- Height: 47" (1,2 m).

## Aspect 100-4T G3 Table



### Aspect 100-4T G3 Table Description:

**Mobile Imaging Table with Motorized Elevation, Trendelenburg Tilt and manual 4-way tabletop float.**

Aspect 100-4T G3 # A100-2602 (U.S accessory rails)

# A100-2831 (Metric accessory rails)

For Advanced Vascular Procedures; Includes short, recessed side rails 5" (12,7 cm) in length at imaging end of table that facilitate use of removable headrest extension (option) and also facilitates attachment of catheter tray extension at narrow end of table. Two separate catheter tray extensions are available: One for the pedestal end of table and one for the imaging end of table. Up to 5 day battery backup pack, 600 lbs (272 kgs) patient load, steer assist caster, 3.75" (9,5 cm) tongue height, 32" (81,3 cm) longitudinal tabletop float and 32" to 45" (81,2 - 114,3 cm) tabletop elevation.

Includes the following:

- A100-2190 pendant hand control
- X100-2492: Tabletop 22"/ 56 cm - 24"/ 61 cm W x 84"/ 213 cm L
- X100-2310 Tabletop Pad, 2" (5,1 cm) thick.
- A270-0173: Panning hand control
- C000-0328: Patient restraint straps



### Aspect 100-4T G3 Basic Vascular Package # A100-2700 (Optional package)

1. A100-2322 Tabletop Catheter Tray Extension: 22" (56 cm) Wide, for Aspect 100-4T G3 table- mounts to imaging end of table only.
2. A100-1007 Clamp-on accessory rail: 6" (15,2 cm) x 1.25" (3,2 cm) rail, for 100-4T and ISR tables
3. A310-056 Arm board: quick-release, rail mounted, includes pad and strap.
4. A100-2244 VAB Arm board: carbon fiber, one-piece, extra wide and rigid arm board for vascular access procedures and angiography of the arm.
5. C000-1181 IDI Medical Grade Anti-Fatigue Mat (24" (61 cm) x 66" (168 cm) x ¾" (1,9 cm) thick for maximum comfort & support.
6. A610-051 Radiation Shield: Articulating, rail-mounted. Attaches to table side-rail at base end of table,



## Aspect 100-4T G3 Table Optional and Replacement Accessories:



Photo	Description <span style="color: red;">Red text = Metric accessory rails</span>	Catalog Number
	<p><b>Clamp-on Accessory Rail</b> Rail is 8 ½" long x ¾" thick x 1-1/8" high.</p> <p><span style="color: red;"><b>Clamp-on Accessory Rail</b></span> <span style="color: red;">10 mm x 25 mm x 216 mm clamp-on accessory rail.</span></p>	<p>A100-1007</p> <p><span style="color: red;">A100-2379</span></p>
	<p><b>Armboard</b> Quick-release, rail mounted (requires Clamp-on Accessory Rail A100-1007 or A100-2379 above) unless used on a table with built-in accessory rails.</p>	<p>A310-056</p> <p><span style="color: red;">A310-062</span></p>
	<p><b>VAB Armboard</b> Carbon fiber, one-piece, extra wide armboard for vascular access procedures (body section slides underpatient/table pad). Includes strap and pad.</p>	<p>A100-2244</p>
	<p><b>Arm Board</b> Carbon fiber, shoulder mount (attaches by sliding thin section under patient/table pad), flat. Includes pad and strap.</p>	<p>A310-059</p>
	<p><b>Headrest Extension</b> Articulating carbon fiber headrest. Attaches to head end of 100-4T G3 table. Includes built in Anesthesia Screen Holder sockets. 23-½"/ 58,7 cm wide x 12"/ 30,5 cm long.</p>	<p>A100-2317</p> <p><span style="color: red;">A100-2505</span></p>
	<p><b>Peripheral Extension</b> Carbon fiber table extension, mounts to imaging end of table only. 22"/ 56 cm wide, 12"/ 30,5 cm long. Maximum weight for this extension is 25 lbs (11,4 Kgs). Requires the table to have an X100-2492 style tabletop.</p>	<p>A100-2486</p>
	<p><b>Tabletop Catheter Tray Extension</b> 24.25"/ 61,6 cm wide, 30"/ 76,2 cm long. Mounts to pedestal end of table only. The maximum weight this extension can support is 20 Lbs (9 Kgs).</p>	<p>A100-1769</p>
	<p><b>Tabletop Catheter Tray Extension</b> 20 ¾"/ 52,7 cm x 27"/ 68,6 cm long. Mounts to imaging end of table only. Requires tabletop X100-2492. The maximum weight this extension can support is 20 Lbs (9 Kgs).</p>	<p>A100-2322</p>



## Aspect 100-4T G3 Table Optional and Replacement Accessories:

	<p><b>Radiation Shield - .5mm equivalence</b> Articulating, rail-mounted. Attaches to table side-rail at base end of table, bi-lateral, adjustable. Articulating joint allows shield to conform to table contour. Snap-on patient side upper section is removable.</p>	<p>A610-051 <b>A610-106</b></p>
	<p><b>Anesthesia Screen Holder</b> Flexible "hoop" style. Mounts directly to A100-2317 Headrest Extension. For use on accessory rails - a pair of rotating side rail clamps, part number C000-0746, are required. Rotating side rail clamps and clamp-on accessory rails are not required if table is ordered with the A100-2317 Headrest Extension.</p>	<p>C000-0965</p>
	<p><b>Side-rail clamp</b> Rotating, with socket for attachment of accessories with 5/8 inch (1,6 cm) circular post. Requires A100-1007 (or A100-2379 for metric rails) clamp-on accessory rail.</p>	<p>C000-0746 <b>C000-1065</b></p>
	<p><b>Heavy Duty Medical Grade Anti-Fatigue Mat</b> (24" (61 cm) x 66" (167,6 cm) x 3/4" (1,9 cm) IDI heavy-duty anti-fatigue mat. One-piece construction for high-traffic areas. Safe &amp; non-toxic, contains no plasticizers and will not leach over time. Durable brushed texture.</p>	<p>C000-1181</p>
	<p><b>Foot Control for 100-4T and 100-4T G3</b> (must verify table serial # with IDI for compatibility)</p>	<p>A100-2360</p>
	<p><b>Panning Hand Control, for 100-4T G3 series.</b> (Included with table).</p>	<p>A270-0173 <b>A270-0179</b></p>
	<p><b>Pendant Hand Control</b> For Aspect 100-4T G3. Controls elevate and tilt functions only (Included with table).</p>	<p>A100-2190</p>

## Aspect 100-4T G3 Table Optional and Replacement Accessories:

Photo	Description <span style="color: red;">Red text = Metric accessory rails</span>	Catalog Number
	<p><b>IV Pole</b> Stainless steel with four bottle hooks Range: 107 - 166 cm Tube diameter: 25 / 18 mm</p> <p><b>IV Pole Clamp C000-1325 is required.</b></p>	C000-1324
	<p><b>IV Pole Clamp</b> Aluminum. 25 mm pole opening</p>	C000-1325

## Shipping Crate Specifications

- Weight (approx.): 750 lbs. (340kg)
- Length: 96" (2,5 m).
- Width: 42" (1,1 m).
- Height: 47" (1,2 m).

## Aspect 100-4 Table



### Aspect 100-4 Description:

The Aspect 100-4 is designed for C-arm imaging in endovascular or other interventional procedures where a 4-way floating tabletop is required in a non-tilting table.

- 4-Way Manual Floating Tabletop
- Motorized Elevation
- 450 lbs (204 kgs) maximum patient weight
- 29.9" to 39.9" (75,9 cm - 101,3 cm) vertical travel
- 40" (101,6 cm) of longitudinal float
- 10" (25,5 cm) transverse float
- Panning control module
- 120VAC is standard.
- 230VAC is optional and must be specified at time of order.

### Aspect 100-4 #A100-2737 (U.S Rails)    A100-2632 (Metric Rails)

Includes the following:



- X100-2599: Tabletop, 21" to 30" wide (53,3 cm to 76,2 cm) x 80" (203 cm) long.
- X100-2650: Tabletop pad, 2" (5,1mm) thick, for 21" to 30" (53,3mm) for 21" to 30" (53,3 cm - 76,2 cm) x 80" (2,03 m) tabletop.
- A270-126: Panning hand control.
- C000-0328: Patient restraint straps.



## Aspect 100-4 Table Optional and Replacement Accessories:

Photo	Description <span style="color: red;">Red text = Metric accessory rails</span>	Catalog Number
	<b>Tabletop Catheter Tray Extension</b> Mounts to pedestal end only.	A100-814
	<b>Armboard</b> Quick-release, rail mounted (requires Clamp-on Accessory Rail A100-1007 or A100-2379 above) unless used on a table with built-in accessory rails.	A310-056  <span style="color: red;">A310-062</span>
	<b>Clamp-on Accessory Rail</b> Rail is 8 1/2" long x 3/8" thick x 1-1/8" high. <span style="color: red;"><b>Clamp-on Accessory Rail</b></span> <span style="color: red;">10 mm x 25 mm x 216 mm clamp-on accessory rail.</span>	A100-2218  <span style="color: red;">A100-2838</span>
	<b>Arm Board</b>  Carbon fiber, shoulder mount (attaches by sliding thin section under patient/table pad), flat. Includes pad and strap.	A310-059
	<b>VAB Armboard</b> Carbon fiber, one-piece, extra wide armboard for vascular access procedures (body section slides underpatient/table pad). Includes strap and pad.	A100-2244
	<b>Radiation Shield - .5mm equivalence</b> Articulating, rail-mounted. Attaches to table side-rail at base end of table, either side, adjustable. Articulating joint allows shield to conform to table contour. Snap-on patient side upper section is removable.	A610-051  <span style="color: red;">A610-106</span>
	<b>Panning Hand Control for Aspect 100-4</b> (Included with table)	A270-126  <span style="color: red;">A270-183</span>
	<b>Heavy Duty Medical Grade Anti-Fatigue Mat</b> (24" (61 cm) x 66" (167,6 cm) x 3/4" (1,9 cm) IDI heavy-duty anti-fatigue mat. One-piece construction for high-traffic areas. Safe & non-toxic, contains no plasticizers and will not leach over time. Durable brushed texture.	C000-1181

## Aspect 100-4 Table Optional and Replacement Accessories:

Photo	Description <span style="color: red;">Red text = Metric accessory rails</span>	Catalog Number
	<p><b>IV Pole</b>                      Stainless steel with four bottle hooks                      Range: 107 - 166 cm                      Tube diameter: 25 / 18 mm</p> <p><b>IV Pole Clamp C000-1325 is required.</b></p>	<p>C000-1324</p>
	<p><b>IV Pole Clamp</b>                      Aluminum. 25 mm pole opening.</p>	<p>C000-1325</p>

## Aspect 100-4 Shipping Crate Specifications

- Weight (approx.): 635 lbs. (288kg)
- Length: 96" (2,4 m)
- Width: 42" (1,07 m)
- Height: 47" (1,2 m)

## Aspect 100-RTL Table



### Aspect RTL Description:

C-Arm table for pain management and other imaging procedures where motorized elevation, tilt, lateral roll and longitudinal motion are required.

- Motorized elevation
- Trendelenburg tilt
- Lateral roll
- Longitudinal motion
- 120VAC is standard
- 230VAC is optional and must be specified at time of order

### Aspect RTL #A100-1254 (120VAC)    A100-2637 (230VAC)

Includes the following:

- X100-995: General Purpose rectangular tabletop 24" x 80" (61 cm) x (203 cm).
- X100-1742: Tabletop pad, 2" (5,1 cm) thick, for 24" (61 cm) x 80" (203 cm) top
- K000-0197: Hand control
- C000-0328: Patient restraint straps
- C000-0597: Crescent shaped facial cushion
- C000-0598: Disposable covers for crescent-shaped facial cushion, box of 50

### Aspect RTL #A100-2646 (120VAC)    A100-2647 (230VAC)

Includes the following:

- X100-733: Pain Management tabletop with facial cutout 22" (56 cm) x 80" (2,03 m).
- X100-1757: Tabletop pad, 2" (5,1 cm) thick, for 22" (56 cm) x 80" (2,03 m) top with facial cutout.
- K000-0197: Hand control
- C000-0328: Patient restraint straps
- C000-0597: Crescent shaped facial cushion
- C000-0598: Disposable covers for crescent-shaped facial cushion, box of 50

Includes the following:

- X100-1325:G.I.rectangular tabletop 28" (71,1 cm) x 80" (2,03 m).
- X100-2083: Tabletop pad, 2" (5,1 cm) thick, for 28" (71,1 cm) x 80" (2,03 m).
- K000-0197: Hand control
- C000-0328: Patient restraint straps
- C000-0597: Crescent shaped facial cushion
- C000-0598: Disposable covers for crescent-shaped facial cushion, box of 50









Aspect 100RTL Table Optional and Replacement Accessories:

Photo	Description <span style="color: red;">Red text = Metric accessory rails</span>	Catalog Number
	<b>Side-rail clamp</b> Rotating, with socket for attachment of accessories with 5/8 inch (1,6 cm) circular post. Requires A100-1007 (or A100-2379 for metric rails) clamp-on accessory rail.	C000-0746 <span style="color: red;">C000-1065</span>
	<b>Armboard</b> Quick-release, rail mounted (requires Clamp-on Accessory Rail A100-1007 or A100-2379).	A310-056 <span style="color: red;">A310-062</span>
	<b>Clamp-on Accessory Rail</b> Rail is 8 1/2" long x 3/8" thick x 1-1/8" high. <span style="color: red;"><b>Clamp-on Accessory Rail</b></span> <span style="color: red;">10 mm x 25 mm x 216 mm clamp-on accessory rail.</span>	A100-1007 <span style="color: red;">A100-2379</span>
	<b>Arm Board</b> Carbon fiber, shoulder mount (attaches by sliding thin section under patient/table pad), flat. Includes pad and strap.	A310-059
	<b>Hand Control, 100RTL</b> (must verify table serial # with IDI for compatibility). Motions controlled: Elevation, Trendelenburg, roll, slide. (Included with table).	K000-0197
	<b>Foot Control for 100RTL</b> Foot Control unit controls all table motions.	A100-1961
	<b>Scatter Guard radiation shield draping</b> For 28" (71,1 cm) wide optional tabletop X100-1325 Dimensions: 59" (1,5 m) long, 24" (61 cm) below tabletop. Draping extends along both sides and head-end of table. Supported by fabric section over tabletop. <i>Not for use with arm board A310-056.</i>	A610-108



## Aspect 100RTL Table Optional and Replacement Accessories:

Photo	Description <span style="color: red;">Red text = Metric accessory rails</span>	Catalog Number
	<p><b>Radiation Shield</b> Fixed shield with integrated clamp system. For use with tables that do not have side rails. Clamps to table sides or at head-end of table. Snap-on upper section above level of tabletop is removable. Use with 100RTL, 100RT, 100T, 100E tables.</p>	A610-080
	<p><b>Scatter-Guard radiation shield draping</b> For for 24" (61 cm) rectangular tabletop X100-995. Dimensions: 59" (1,5 m) long. 24" (61 cm) draping below tabletop. Draping extends along both side and head-end of table. Supported by fabric section over tabletop <i>Note: Not for use with arm board A310-056.</i></p>	A610-096
	<p><b>Scatter-Guard radiation shield draping</b> for 22" (56 cm) tabletop X100-733 models with 22" (56 cm) tapered-end tabletop with facial cutout. Dimensions: 59" (1,5 m) long. 24" (61 cm) draping below tabletop. Draping extends along both side and head-end of table. Supported by fabric section over tabletop. <i>Note: Not for use with arm board A310-056.</i></p>	A610-092
	<ul style="list-style-type: none"> <li>• Facial Cushion, crescent shape.</li> <li>• Disposable covers for facial cushion, box of 50.</li> </ul>	Cushion: #C000-0597 Covers: #C000-0598
	<p><b>Heavy Duty Medical Grade Anti-Fatigue Mat</b> 24" (61 cm) x 66" (167,6 cm) x 3/4" (1,9 cm) IDI heavy-duty anti-fatigue mat. One-piece construction for high-traffic areas. Safe &amp; non-toxic, contains no plasticizers and will not leach over time. Durable brushed texture.</p>	C000-1181
	<p><b>IV Pole</b> Stainless steel with four bottle hooks Range: 107 - 166 cm Tube diameter: 25 / 18 mm <b>IV Pole Clamp C000-1325 is required.</b></p>	C000-1324
	<p><b>IV Pole Clamp</b> Aluminum. 25 mm pole opening <b>Clamp-on Accessory Rail A100-1007 is required.</b></p>	C000-1325

## 100RTL Shipping Crate Specifications

- Weight (approx.): 605 lbs. (274kg)
- Length: 96" (2,44 m).
- Width: 42" (1,1 m).
- Height: 47" (1,2 m)

## Aspect 100RT Mobile Imaging Table



### Aspect 100RT Description:

C-arm table for pain management and other imaging procedures where motorized elevation, tilt and lateral roll are required.

- Motorized Elevation
- Trendelenburg tilt
- Lateral Roll
- 120VAC is standard
- 230VAC is optional and must be specified at time of order.

### Aspect 100RT #A100-870 (120VAC)    A100-2636 (230VAC)

Includes the following:

- X100-995: General Purpose rectangular tabletop 24" x 80" (61 cm x 203cm).
- X100-1742: Tabletop pad, 2" (5,1cm thick, for 24" (61 cm) x 80" (203cm) top.
- K000-0195: Hand control.
- C000-0328: Patient restraint straps.
- C000-0597: Crescent shaped facial cushion.
- C000-0598: Disposable covers for crescent-shaped facial cushion, box of 50.

### Aspect 100RT #A100-2644 (120VAC)    A100-2645 (230VAC)

Includes the following:

- X100-733: Pain Management tabletop with facial cutout 22" (56 cm) x 80" (2,03 m).
- X100-1757: Tabletop pad, 2" (5,1 cm) thick, for 22" (56 cm) x 80" (2,03 m) top with facial cutout.
- K000-0195: Hand control.
- C000-0328: Patient restraint straps.
- C000-0597: Crescent shaped facial cushion.
- C000-0598: Disposable covers for crescent-shaped facial cushion, box of 50.

## Aspect 100RT #A100-2660 (120VAC) #A100-2661(230VAC)

Includes the following:

- X100-1325: G.I. rectangular tabletop 28" (71,1 cm) x 80" (2,03 m).
- X100-2083: Tabletop pad, 2" (5,1 cm) thick, for 28" (71,1 cm) x 80" (2,03m)
- K000-0195: Hand control.
- C000-0328: Patient restraint straps.
- C000-0597: Crescent shaped facial cushion.
- C000-0598: Disposable covers for crescent-shaped facial cushion, box of 50.



### Aspect 100RT Table Optional and Replacement Accessories:

Photo	Description <span style="color: red;">Red text = Metric accessory rails</span>	Catalog Number
	Rotating, with socket for attachment of accessories with 5/8 inch (1,6 cm) circular post. Requires A100-1007 (or A100-2379 for metric rails) clamp-on accessory rail.	C000-0746 <span style="color: red;">C000-1065</span>
	<b>Armboard</b> Quick-release, rail mounted. requires Clamp-on Accessory Rail A100-1007 or A100-2379.	A310-056 <span style="color: red;">A310-062</span>
	<b>Clamp-on Accessory Rail</b> Rail is 8 1/2" long x 3/8" thick x 1-1/8" high. <span style="color: red;"><b>Clamp-on Accessory Rail</b></span> <span style="color: red;">10 mm x 25 mm x 216 mm clamp-on accessory rail.</span>	A100-1007 <span style="color: red;">A100-2379</span>
	<b>Arm Board</b> Carbon fiber, shoulder mount (attaches by sliding thin section under patient/table pad), flat. Includes pad and strap.	A310-059
	<b>Scatter Guard radiation shield draping</b> For 28" (71,1 cm) wide optional tabletop X100-1325 Dimensions: 59" (1,5 m) long, 24" (61 cm) below tabletop. Draping extends along both sides and head-end of table. Supported by fabric section over tabletop. <i>Not for use with arm board A310-056.</i>	A610-108
	<b>Hand Control, 100RT</b> Must verify table serial # with IDI for compatibility. (Included with table).	K000-0195

## Aspect 100RT Table Optional and Replacement Accessories:

Photo	Description <span style="color: red;">Red text = Metric accessory rails</span>	Catalog Number
	<b>Foot Control</b> for 100RT (must verify table serial # with IDI for compatibility).	A100-1960
	<b>Radiation Shield</b> Fixed shield with integrated clamp system. For use with tables that do not have side rails. Clamps to table sides or at head-end of table. Snap-on upper section above level of tabletop is removable. Use with 100RTL, 100RT, 100T, 100E tables.	A610-080
	<b>Scatter-Guard radiation shield draping</b> For for 24" (61 cm) rectangular tabletop X100-995. Dimensions: 59" (1,5 m) long. 24" (61 cm) draping below tabletop. Draping extends along both side and head-end of table. Supported by fabric section over tabletop <i>Note: Not for use with arm board A310-056.</i>	A610-096
	<b>Scatter-Guard radiation shield draping</b> for 22" (56 cm) tabletop X100-733 models with 22" (56 cm) tapered-end tabletop with facial cutout. Dimensions: 59" (1,5 m) long. 24" (61 cm) draping below tabletop. Draping extends along both side and head-end of table. Supported by fabric section over tabletop. <i>Note: Not for use with arm board A310-056.</i>	A610-092
	<ul style="list-style-type: none"> <li>• Facial Cushion, crescent shape.</li> <li>• Disposable covers for facial cushion, box of 50.</li> </ul>	Cushion: #C000-0597 Covers: #C000-0598
	<b>Heavy Duty Medical Grade Anti-Fatigue Mat</b> (24" (61 cm) x 66" (167,6 cm) x ¾" (1,9 cm) IDI heavy-duty anti-fatigue mat. One-piece construction for high-traffic areas. Safe & non-toxic, contains no plasticizers and will not leach over time. Durable brushed texture.	C000-1181
	<b>IV Pole</b> Stainless steel with four bottle hooks Range: 107 - 166 cm Tube diameter: 25 / 18 mm  <b>IV Pole Clamp C000-1325 is required.</b>	C000-1324

## Aspect 100RT Table Optional and Replacement Accessories:

 A silver aluminum IV pole clamp with a black base and a 25 mm pole opening.	<p><b>IV Pole Clamp</b> Aluminum. 25 mm pole opening.</p> <p><b>Clamp-on Accessory Rail A100-1007 is required.</b></p>	C000-1325
---	--	-----------

## 100RT Shipping Crate Specifications

- Weight (approx.): 571 lbs. (259 kg.)
- Length: 96" (2,4 m)
- Width: 42" (1,01 m)
- Height: 47" (1,2 m)

## Aspect 100T Mobile Imaging Table



### Aspect 100T Description:

C-arm table for pain management and other procedures where motorized elevation and Trendelenburg tilt are required.

- Motorized Elevation
- Trendelenburg tilt
- 120VAC is standard
- 230VAC is optional and must be specified at time of order.

### Aspect 100T #A100-658 (120VAC)    A100-2638 (230VAC)

Includes the following:

- X100-995: General Purpose rectangular tabletop 24" x 80" (61 cm) x (203cm)
- X100-1742: Tabletop pad, 2" (5,1 cm) thick, for 24" (61 cm) x 80" (203 cm) top.
- K000-0054: Hand control.
- C000-0328: Patient restraint straps.
- C000-0597: Crescent shaped facial cushion.
- C000-0598: Disposable covers for crescent-shaped facial cushion, box of 50.

### Aspect 100T #A100-2648 (120VAC)    A100-2649 (230VAC)

Includes the following:

- X100-733: Pain Management tabletop with facial cutout 22" (56 cm) x 80" (2,03 cm).
- X100-1757: Tabletop pad, 2" (5,1 cm) thick, for 22" (56 cm) x 80" (2,03 cm) top with facial cut-out.
- K000-0054: Hand control.
- C000-0328: Patient restraint straps.
- C000-0597: Crescent shaped facial cushion.
- C000-0598: Disposable covers for crescent-shaped facial cushion, box of 50.



**Aspect 100T #A100-2658 (120VAC)    A100-2659 (230VAC)**

Includes the following:

- X100-1325: G.I. rectangular tabletop 28" (71,1 cm) x 80" (2,03 m).
- X100-2083: Tabletop pad, 2" (5,1 cm) thick, for 28" (71,1 cm) x 80" (2,03m).
- K000-0054: Hand control.
- C000-0328: Patient restraint straps.
- C000-0597: Crescent shaped facial cushion.
- C000-0598: Disposable covers for crescent-shaped facial cushion, box of 50.



**Aspect 100T Table Optional and Replacement Accessories:**

Photo	Description <span style="color: red;">Red text = Metric accessory rails</span>	Catalog Number
	<p><b>Clamp-on Accessory Rail</b> Rail is 8 ½" long x ¾" thick x 1-1/8" high.</p> <p><b>Clamp-on Accessory Rail</b> <span style="color: red;">10 mm x 25 mm x 216 mm clamp-on accessory rail.</span></p>	<p>A100-1007</p> <p><span style="color: red;">A100-2379</span></p>
	<p>Rotating, with socket for attachment of accessories with 5/8 inch (1,6 cm) circular post. Requires A100-1007 (or A100-2379 for metric rails) clamp-on accessory rail.</p>	<p>C000-0746</p> <p><span style="color: red;">C000-1065</span></p>
	<p><b>Arm Board</b> Carbon fiber, shoulder mount (attaches by sliding thin section under patient / table pad), flat. Includes pad and strap.</p>	<p>A310-059</p>
	<p><b>Scatter Guard radiation shield draping</b> For 28" (71,1 cm) wide optional tabletop X100-1325 Dimensions: 59" (1,5 m) long, 24" (61 cm) below tabletop. Draping extends along both sides and head-end of table. Supported by fabric section over tabletop. <i>Not for use with arm board A310-056.</i></p>	<p>A610-108</p>
	<p><b>Hand Control</b> for 100T table. Elevate and tilt functions. (Included with table).</p>	<p>K000-0054</p>
	<p><b>Foot Control for 100T</b> Substitute for hand control. Cannot use hand and foot control at the same time.</p>	<p>A100-500</p>

## Aspect 100T Table Optional and Replacement Accessories:

Photo	Description <span style="color: red;">Red text = Metric accessory rails</span>	Catalog Number
	<p><b>Radiation Shield</b> Fixed shield with integrated clamp system. For use with tables that do not have side rails. Clamps to table sides or at head-end of table. Snap-on upper section above level of tabletop is removable. Use with 100RTL, 100RT, 100T, 100E tables.</p>	A610-080
	<p><b>Scatter-Guard radiation shield draping</b> For for 24" (61 cm) rectangular tabletop X100-995. Dimensions: 59" (1,5 m) long. 24" (61 cm) draping below tabletop. Draping extends along both side and head-end of table. Supported by fabric section over tabletop <i>Note: Not for use with arm board A310-056.</i></p>	A610-096
	<p><b>Scatter-Guard radiation shield draping</b> for 22" (56 cm) tabletop X100-733 models with 22" (56cm) tapered-end tabletop with facial cutout. Dimensions: 59" (1,5 m) long. 24" (61 cm) draping below tabletop. Draping extends along both side and head-end of table. Supported by fabric section over tabletop. <i>Note: Not for use with arm board A310-056.</i></p>	A610-092
	<ul style="list-style-type: none"> <li>• Facial Cushion, crescent shape.</li> <li>• Disposable covers for facial cushion, box of 50.</li> </ul>	Cushion: #C000-0597 Covers: #C000-0598
	<p><b>Heavy Duty Medical Grade Anti-Fatigue Mat</b> (24" (61 cm) x 66" (167,6 cm) x ¾" (1,9 cm) IDI heavy-duty anti-fatigue mat. One-piece construction for high-traffic areas. Safe &amp; non-toxic, contains no plasticizers and will not leach over time. Durable brushed texture.</p>	C000-1181
	<p><b>IV Pole</b> Stainless steel with four bottle hooks Range: 107 - 166 cm Tube diameter: 25 / 18 mm</p> <p><b>IV Pole Clamp C000-1325 is required.</b></p>	C000-1324
	<p><b>IV Pole Clamp</b> Aluminum. 25 mm pole opening</p> <p><b>Clamp-on Accessory Rail A100-1007 is required.</b></p>	C000-1325

## 100T Shipping Crate Specifications

- Weight (approx): 540 lbs./254kg
- Length: 96" (2,4 m)
- Width: 42" (1,1 m).
- Height: 47" (1,2 m)

## Aspect 100E Mobile Imaging Table



### Aspect 100E Description:

C-arm table for pain management and other procedures where motorized elevation is the only movement required.

- 120VAC is standard.
- 230VAC is optional and must be specified at time of order.

### Aspect 100E #A100-402 (120VAC)    A100-2635 (230VAC)

Includes the following:

- X100-995: General Purpose rectangular tabletop 24" x 80" (61 cm) x (203cm).
- X100-1742: Tabletop pad, 2" (5,1 cm) thick, for 24" (61 cm) x 80" (203cm) top.
- K000-0041: Hand control.
- C000-0328: Patient restraint straps.
- C000-0597: Crescent shaped facial cushion.
- C000-0598: Disposable covers for crescent-shaped facial cushion, box of 50.

### Aspect 100E #A100-2642 (120VAC)    A100-2643 (230VAC)

Includes the following:

- X100-733: Pain Management tabletop with facial cutout 22" (56 cm) x 80" (2,03 m).
- X100-1757: Tabletop pad, 2" (5,1 cm) thick, for 22" (56 cm) x 80" (2,03 m) top with facial cutout.
- K000-0041 Pendant hand control.
- C000-0328: Patient restraint straps.
- C000-0597: Crescent shaped facial cushion.
- C000-0598: Disposable covers for crescent-shaped facial cushion, box of 50.

**Aspect 100E #A100-2656 (120VAC)    A100-2657 (230VAC)**

Includes the following:





- X100-1325: GI rectangular tabletop 28" (71,1 cm) x 80" (2,03 m).
- X100-2083: Tabletop pad, 2" (5,1 cm) thick, for 28" (71,1 cm) x 80" (2,03m).
- K000-0041: Hand control.
- C000-0328: Patient restraint straps.
- C000-0597: Crescent shaped facial cushion.
- C000-0598: Disposable covers for crescent-shaped facial cushion, box of 50.



**Aspect 100E Table Optional and Replacement Accessories:**

Photo	Description <span style="color: red;">Red text = Metric accessory rails</span>	Catalog Number
	<p><b>Clamp-on Accessory Rail</b> Rail is 8 ½" long x ¾" thick x 1-1/8" high.</p> <p><b>Clamp-on Accessory Rail</b> <span style="color: red;">10 mm x 25 mm x 216 mm clamp-on accessory rail.</span></p>	<p>A100-1007</p> <p><span style="color: red;">A100-2379</span></p>
	<p>Rotating, with socket for attachment of accessories with 5/8 inch (1,6 cm) circular post. Requires A100-1007(or A100-2379 for metric rails) clamp-on accessory rail.</p>	<p>C000-0746</p> <p><span style="color: red;">C000-1065</span></p>
	<p><b>Arm Board</b> Carbon fiber, shoulder mount (attaches by sliding thin section under patient / table pad), flat. Includes pad and strap.</p>	<p>A310-059</p>
	<p><b>Scatter Guard radiation shield draping</b> For 28" (71,1 cm) wide optional tabletop X100-1325 Dimensions: 59" (1,5 m) long, 24" (61 cm) below tabletop. Draping extends along both sides and head-end of table. Supported by fabric section over tabletop. <i>Not for use with arm board A310-056.</i></p>	<p>A610-108</p>
	<p><b>Hand control for 100E.</b> (Included with table).</p>	<p>K000-0041</p>
	<p><b>Foot Control 100E</b></p>	<p>A100-758</p>
	<p><b>Radiation Shield</b> Fixed shield with integrated clamp system. For use with tables that do not have side rails. Clamps to table sides or at head-end of table. Snap-on upper section above level of tabletop is removable. Use with 100RTL, 100RT, 100T, 100E tables.</p>	<p>A610-080</p>

## Aspect 100E Table Optional and Replacement Accessories:

Photo	Description <b>Red text = Metric accessory rails</b>	Catalog Number
	<b>Scatter-Guard radiation shield draping</b> For for 24" (61 cm) rectangular tabletop X100-995. Dimensions: 59" (1,5 m) long. 24" (61 cm) draping below tabletop. Draping extends along both sides and head-end of table. Supported by fabric section over tabletop <i>Note: Not for use with arm board A310-056.</i>	A610-096
	<b>Scatter-Guard radiation shield draping</b> for 22" (56 cm) tabletop X100-733 models with 22" (56 cm) tapered-end tabletop with facial cutout. Dimensions: 59" (1,5 m) long. 24" (61 cm) draping below tabletop. Draping extends along both sides and head-end of table. Supported by fabric section over tabletop. <i>Note: Not for use with arm board A310-056.</i>	A610-092
	<ul style="list-style-type: none"> <li>• Facial Cushion, crescent shape.</li> <li>• Disposable covers for facial cushion, box of 50.</li> </ul>	Cushion: #C000-0597 Covers: #C000-0598
	<b>Heavy Duty Medical Grade Anti-Fatigue Mat</b> (24" (61 cm) x 66" (167,6 cm) x ¾" (1,9 cm) IDI heavy-duty anti-fatigue mat. One-piece construction for high-traffic areas. Safe & non-toxic, contains no plasticizers and will not leach over time. Durable brushed texture.	C000-1181
	<b>IV Pole</b> Stainless steel with four bottle hooks Range: 107 - 166 cm Tube diameter: 25 / 18 mm <b>IV Pole Clamp C000-1325 is required.</b>	C000-1324
	<b>IV Pole Clamp</b> Aluminum. 25 mm pole opening. <b>Clamp-on Accessory Rail A100-1007 is required.</b>	C000-1325

## 100E Shipping Crate Specifications

- Weight (approx.): 495 lbs. (225kg)
- Length: 96" (2,4 m)
- Width: 42" (1,1 m).
- Height: 47" (1,2 m).

## Aspect 100-UCPLUS Urology/Multi-purpose Table



Shown with optional leg holders (#A100-2247).



Shown with tabletop extension (A100-1400)

### Aspect 100UCPlus description:

Imaging table for urology and multi-purpose use. Urological accessories are easily removable so the table can be quickly configured for multi-purpose C-arm imaging or general patient positioning for non-urological procedures. A removable radiographic cassette tray provides KUB radiography compatibility with mobile x-ray machines, including both conventional film/grid systems and digital detectors.

- 120VAC is standard.
- 230VAC is optional and must be specified at time of order.







Aspect 100UCPlus #A100-1517 (120VAC)    **A100-2639 (230VAC)**

Includes the following:

- A100-1876 Stirrups Mounting Rail extension Kit.
- X100-1818: tabletop pad, 28" (71,1 cm) x 46 ½" (118,1 cm) x 2" (5,1 cm) thick.
- A100-1400: Tabletop extension, 24" (61 cm)W x 34" (86,4 cm) (Metric tables #A100-2675)
- X100- 1817: Tabletop extension pad, 24" (61 cm) x 34" (86,4 cm) x 2" (5,1 cm) thick.
- K000-0158: Pendant hand control.
- A100-1540: Foot switch control.
- U100-3025: Removable x-ray shield flap, for perineal end of table.
- C000-0571: Patient restraint straps.
- A310-056: Arm board, rail mounted, with pad and strap (A310-062 for metric rails).
- C000-0595: Urology drain bag support hoop.
- C000-0593: Disposable drain bag & hose ass'y, (Qty of 1).
- C000-0492: Disposable covers for foot switch, box of 50.
- C000-0645: Disposable tabletop pad protector (qty. of 1).
- C000-0612: 5 gallon collection bag (qty of 1).







## Aspect 100UCPlus Optional and Replacement Accessories:

Photo	Description <b>Red text = Metric accessory rails</b>	Catalog Number
	<p><b>IDI ComfortFin 350 Lithotomy Leg holders (Stirrups pair only)</b> ComfortFin Lithotomy Leg holders are designed to improve infection control with durable, easy to clean silicone straps. Includes integrated lateral fin to help protect the head of the fibula and the peroneal nerve. 4" (10,2 cm) more working space with an increased range of motion. 350 lbs (159 kgs).</p>	C100-3042
	<p>Kit: IDI ComfortFin350 Lithotomy Leg holders C100-3042 with C100-3046 economy side-rail clamps</p>	<p>A100-2246 <b>A100-3074</b></p>
	<p><b>IDI ComfortFin 500 Lithotomy Leg holders (Stirrups pair only)</b> ComfortFin Lithotomy Leg holders are designed to improve infection control with durable, easy to clean silicone straps. Includes integrated lateral fin to help protect the head of the fibula and the peroneal nerve. Boots are sized for today's heavier patients. 4" (10,2cm) more working space with an increased range of motion. Patient weight capacity: 500 lbs. (227kg).</p>	C100-3045
	<p>Kit: IDI ComfortFin 500 Lithotomy Leg holders C100-3045 with C100-3046 economy side-rail clamps.</p>	<p>A100-2247 <b>A100-3075</b></p>
	<p><b>Side-rail clamp, removable. IDI 4100.</b> Attaches and locks anywhere on the side rail for fast and easy mounting . A push button safely releases rail clamp helps to prevent false rail engagement. Autoclavable.</p>	<p>C100-3043 <b>C100-3076</b></p>
	<p><b>Economy side-rail clamp.</b> Attaches anywhere on the table rail for fast and easy mounting. Rounded ergonomic shape is easy on the hands. Autoclavable.</p>	<p>C100-3046 <b>C100-3077</b></p>
	<p><b>Lithotomy Leg Holder Cart</b> Easy to push/pull with ergonomic handles. Stirrups are isolated to prevent damage. Clamp storage compartment. Designed to safely store ComfortFin stirrups when not in use.</p>	C100-3044
	<p><b>Single Use Stirrup Boot Cover</b> Waterproof single use stirrup boot covers help eliminate strike through and bacterial migration. Infectious patients (known or suspected). Patients with open sores, abrasion or lesions. Protect against cross-contamination. <i>Available Q3 2019.</i></p>	C100-3070





## Aspect 100UCPlus Optional and Replacement Accessories:

Photo	Description <span style="color: red;">Red text = Metric accessory rails</span>	Catalog Number
	<b>Physician Elbow Supports (pair)</b> Removable	C000-0594
	<b>Armboard</b> Quick-release, rail mounted (requires Clamp-on Accessory Rail A100-1007 or A100-2379 above) unless used on a table with built-in accessory rails.	A310-056 <span style="color: red;">A310-062</span>
	<b>Split Leg Holders</b> For use with Aspect 100UC Plus Tables. Includes pads. Prone percutaneous, lateral or modified lateral nephrostomy. Includes two split leg holder clamps# C000-1115 or <span style="color: red;">C000-1217</span> .	C000-1146 <span style="color: red;">C000-1216</span>
	<b>Replacement Split Leg Holder Clamp</b> For use with split leg holders. # C000-1146 and <span style="color: red;">C000-1216</span>	C000-1115 <span style="color: red;">C000-1217</span>
	<b>IV Pole</b> Stainless steel with four bottle hooks Range: 107 - 166 cm Tube diameter: 25 / 18 mm  <b>IV Pole Clamp C000-1325 is required.</b>	C000-1324
	<b>IV Pole Clamp</b> Aluminum. 25 mm pole opening	C000-1325
	<b>Clamp-on Accessory Rail</b> Rail is 8 1/2" long x 3/8" thick x 1-1/8" high. <span style="color: red;">Clamp-on Accessory Rail</span> <span style="color: red;">10 mm x 25 mm x 216 mm clamp-on accessory rail.</span>	A100-2218 <span style="color: red;">A100-2838</span>
	<b>Stirrups Mounting Rail extension Kit</b> Included with table. For use with leg-holders (Leg-holders are sold separately).	#A100-1876 <span style="color: red;">A100-2676</span>





## Aspect 100UCPlus Optional and Replacement Accessories:

Photo	Description <b>Red text = Metric accessory rails</b>	Catalog Number
	<b>Hand Control for 100UCPlus and 100UC.</b> Controls height up/down, trendelenburg/revers, slide, cross table movements. (Included with table).	K000-0158
	<b>Foot Switch Control for 100UCPlus.</b> (Included with table).	A100-1540
	Rotating, with socket for attachment of accessories with 5/8 inch (1,6 cm) circular post. Requires A100-1007 (or A100-2379 for metric rails) clamp-on accessory rail.	C000-0746 <b>C000-1065</b>
	<b>Removable radiographic cassette tray.</b> Loads from either side of table.	W100-1001

## Aspect 100UCPlus Consumables

Photo	Description <b>Red text = Metric accessory rails</b>	Catalog Number
	<b>Vinyl Urology Table Covers</b> Box of 20	C000-0645
	<b>Uro Drain Bags with Hose</b> Disposable drain bag and hose assembly. Box of 20	<b>Sterile:</b> # C000-0593  <b>Non-sterile:</b> #C000-1111
	<b>Disposable Covers for Aspect 100UCPlus Foot Controls</b> 24" x 20" (61 cm x 51 cm). Box of 50	C000-0492
	<b>Uro Drain Support Hoop</b> Collapsible & removable drain bag support hoop.	C000-0595

## Aspect 100UCPlus Consumables

Photo	Description <b>Red text = Metric accessory rails</b>	Catalog Number
	<b>3"/ 76mm Restraint Straps (Pair)</b> Fabric with velcro fasteners for Aspect 100UCPlus table.	C000-0571
	<b>Restraint Straps</b> One each 3" and 5" (7,6 cm and 12,7 cm) Fabric with velcro fasteners for Aspect 100UCPlus table.	C000-0328
	<b>Uro Collection Unit</b> 5 gallon / 18.9 liter capacity capacity, Box of 10. Soft sided Vinyl container gently expands into a cube as it collects waste fluid when floor drain or suction is unavailable. Internal baffle system enables container to fill evenly as powder converts liquid to gel. Built in zipper and handles allow for storage, closure of drain bag and hose assembly for enhanced infection control during transport and disposal.	C000-0612
	<b>Uro Collection Unit</b> 15 liter capacity, Box of 10. Flexible plastic sided container expands into a cube as it collects waste fluid when floor drain or suction is unavailable. Internal baffle system enables container to fill evenly as powder converts liquid to gel. Integrated valve system allows user to shut off the flow of liquid from the drain bag in order to change collection units.	C000-1307

## Aspect 100UCPlus Shipping Crate Specifications

- Weight (approx.): 815 lbs. (370kg)
- Length: 96" (2,4 m)
- Width: 42" (1,1 m)
- Height: 47" (1,2 m)

## Aspect 100-US Gyn/Fertility Clinic Table



**Aspect 100US A100-1479 (120VAC)    A100-2674 (230VAC)**

GYN / Fertility Mobile Imaging Table.

Table elevation: 26" - 38" (66 - 96.5cm)

An economical C-Arm table for hysterosalpingograms.





Includes the following:

- A100-758: Foot control.
- X100-1687: tabletop pad, 24" x 46" (61 cm x 116,8 cm) 1" (2,54 cm) thick.
- C000-0571: Patient restraint straps.
- A100-2380: Leg support tabletop extension with pad.
- A100-2248: Basic Knee Crutches [pair] with a pair of rotating side rail clamps [C000-0746]

### Aspect 100US Optional and Replacement Accessories:

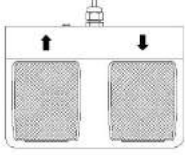
Photo	Description <b>Red text = Metric accessory rails</b>	Catalog Number
	<b>Armboard</b> Quick-release, rail mounted.	A310-056  A310-062
	<b>Hand control for 100US</b>	K000-0041
	<b>Basic Knee Crutches</b> For patients up to 400 lbs (181 kgs). Basic pair with pads. Includes two C000-0746 rotating side rail clamps.	A100-2248  A100-2677

## Aspect 100US Optional and Replacement Accessories:

Photo	Description <b>Red text = Metric accessory rails</b>	Catalog Number
	<b>Foot Control 100US</b> (Included with table.)	A100-758
	Rotating, with socket for attachment of accessories with 5/8 inch (1,6 cm) circular post. Requires A100-1007 (or A100-2379 for metric rails) clamp-on accessory rail.	C000-0746  <b>C000-1065</b>
	<b>IV Pole</b> Stainless steel with four bottle hooks Range: 107 - 166 cm Tube diameter: 25 / 18 mm  <b>IV Pole Clamp C000-1325 is required.</b>	C000-1324
	<b>IV Pole Clamp</b> Aluminum. 25 mm pole opening.	C000-1325

## Aspect 100US Shipping Crate Specifications

Weight (approx.): 245 kg / 540 lbs.

Length: 96 in. (2,4 m).

Width: 42 in. (107 cm).

Height: 47 in. (119 cm).

## MDS Video Integration System



### MDS Description # A280-0330 (120VAC) #A280-0335 (230 Volt)

MDS Mobile Display System, Complete with High Definition Video Monitors, Router and tablet controller.

- 120VAC is standard.
- 230VAC is optional and must be specified at time of order.

Includes the following:

- Dual-Arm Mobile Display Stand with adjustable counterbalanced arms.
- Adjustable shelves for placement of ancillary equipment (Qty. of 4).
- Bilateral input source cable manifold supporting DVI, SDI, VGA, S-Video, SOG and composite inputs.
- Built-in isolation transformer and 8 outlet power strip for video and ancillary equipment AC power.
- FSN 26" (66 cm) HD LED Widescreen Multi-Modality Video Monitors (Qty of 2).
- FSN IPS1000 Video Router / Controller with 10.1" (25,6 cm) Tablet Controller and articulated support arm with lock.
- Dual 8" (20 cm) "Preview" LCD Reference Monitors, mounted to MDS stand center column.
- Qty (1) External cable storage hook.
- Qty (1) Kit - Accessory Basket Kit.
- Protective covers with storage for 26" (66 cm) FSN monitors (Qty of 2).
- Video Cable kit, including common cables / connectors needed for connection of C-Arm and equipment that will be mounted onto the MDS Mobile Display System. Customer choice of one of the following cable kits is included with the MDS System.

#### Customers must specify cable kit choice with order:



- **A280-0325:** Cable kit for GE OEC 9800/9900 C-Arms and camera cable kit for systems mounted onto the MDS.
- **A280-0328:** Cable kit for all DVI output C-Arms and camera cable kit for systems mounted onto the MDS.
- **A280-0326:** Cable kit for Siemens VGA C-Arm with camera cable kit for systems mounted onto the MDS.
- **A280-0425:** Cable kit for Siemens Cios C-Arm with Video Manager and camera cable kit for systems mounted on the MDS.



## MDS Optional Cable Kits and Replacement Accessories:

Photo	Description	Catalog Number
	<p><b>External Source Cable Kit</b> Add this Kit if the customer plans to add any external device that is not mounted directly onto the MDS stand other than the C Arm (i.e. ultrasound, PACS, hemodynamics) Kit Includes: qty (1) each of 20 ft. (6,1m) S Video, (1) 23 ft. (7m) HDMI, 20 ft. (6,1m) SVG cable and qty. (2) short DVI to HDMI adapters.</p>	A280-0437
	<p><b>Endo Shelf</b> Bilateral slide-out shelf, increases storage and shelf space For MDS or MDS D.</p>	A280-0415
	<p><b>CO<sub>2</sub> gas brackets</b> Pair of holders for type E gas cylinders (for insufflator use) mounted to sides of MDS stand.</p>	A280-0401
		
	<p><b>Medical Rail Shelf</b> Shelf Includes medical rails. For accessory attachments.</p>	A280-0130
	<p><b>Shelf with Keyboard</b> Kit includes sliding keyboard carriage. Suitable for most standard customer-supplied keyboards.  Will attach to existing shelves.</p>	A280-0526
	<p><b>Accessory Basket Kit</b> For customer-supplied foot switch or other storage.</p>	A282-0007
	<p><b>Suction Canister Kit</b> Includes: Suction canister rail clamps, bracket and 3000 ml canister.</p>	A282-0009
	<p><b>Cable Hook</b> Cable storage J-hook for external cables.</p>	A280-0570

## MDS Optional and Replacement Accessories:

Photo	Description	Catalog Number
	<p><b>IV Pole Kit</b> Includes two IV rail clamps suitable for mounting a 4' (122 cm) 2-hook IV pole onto two medical rail equipped (A280-0130) shelves. Note: this option requires two shelves with medical rails. This IV pole kit is for MDS systems only.</p>	<p>A280-0508</p>
	<p><b>MDS Monitor Protection Covers</b> For 26" (66 cm) flat panel monitor. (2 covers are included with MDS System A280-0330)</p>	<p>X280-0262</p>

## MDS Optional and Replacement Accessories:

Description	Catalog Number
<p><b>MDS Installation options</b>                      System installation by IDI, including two-day operator in-service training, is available for the USA and Canada. Dealers who choose to have IDI perform the technical installation only will receive a discount provided they supply two days of certified clinical training. Additional in-service training of more than two days is available on a billable basis only. Contact IDI regarding fees for additional training. Installation costs are not discountable and installation is only available in the USA and Canada. Installation outside of the USA and Canada is the responsibility of the dealer.</p>	
<p><b>MDS Installation, technical integration and clinical training by IDI in the continental United States</b></p>	<p>Y-MDSINS-01</p>
<p><b>MDS installation and integration only by IDI technician in Continental United States</b>                      OEM agrees to supply 2-day certified clinical applications training to customer.</p>	<p>Y-MDSINS-04</p>
<p><b>MDS Installation, integration and clinical training by IDI in Alaska or Hawaii</b>                      4-day installation, integration and clinical operation training by IDI.</p>	<p>Y-MDSINS-02</p>
<p><b>MDS Installation, integration and clinical training by IDI in Canada</b>                      4-day installation, integration and clinical operation training by IDI.</p>	<p>Y-MDSINS-03</p>

## ilex55 Video Integration System



### ilex55 Description

The Ilex 55 mobile video platform features a FSN 55" (139,7 cm) 4K UHD resolution monitor on a mobile platform. The system can display one 4K UHD or multiple HD resolution clinical images in a single, split screen, or quadscreen mode.

**ilex55**

**#A280-600 (120VAC)**

**#A280-0781 (230 Volt)**

Includes the following:

- FSN 55" (139,7 cm) 4K UHD medical monitor.
- Three equipment shelves 19" (48 cm) x 28" (71 cm) and one platform 19" (48 cm) x 20" (51 cm).
- Two video cable storage hooks.
- 5" (12,7 cm) casters with lock, free float and directional control.
- Support column with powered 20" (51 cm) vertical travel and 0°, 2.5° and 5° manual tilt.
- Bluetooth speaker system with volume control.
- Configurable video signal input panels with four DVI inputs, three BNC inputs, one S-Video input, and four VGA inputs.
- Four USB ports.
- Two 120V power ports.
- Remote control capability for monitor PIP functions: single, side-by-side or quad modes.
- Vertical transport handles.
- Cable kit suitable for connecting one SOG Lex / Right C-Arm, one DVI Left / Right C-Arm, one VGA Ultrasound or hemodynamic monitor, and one DVI ultrasound or camera.
- Two IR remote monitor controllers.
- Two boxes of sterile remote control drapes 15 per box.

## ilex55 Power Options

### Option 1: North American Version, 15 amp.

For connection to 110-120 VAC, 60Hz, 15 amp outlet, 12 amp max load rating. Includes one built-in 800 VA isolation transformer and 20 ft., 20 amp power cord, 8 position power strip (12A max draw)

### Option 2: EU Version.

For connection to 220-240 VAC, 50Hz, 10 amp outlet. Includes one 800 VA isolation transformer, 20 ft. (6,1 m) power cord and plug (must specify country). 8 position power strip (7A max draw).

## ilex55 Dimensions and weight

- Base cover: 31 in.(79 cm) wide x 29 in. (74 cm) deep.
- Maximum base footprint: 36 in. (92 cm) wide x 35 in. (89 cm) deep.
- Monitor Handles are 55 in. (140 cm) wide.
- Height with monitor retracted: 72 in. (182 cm).
- Height with monitor extended: 92 in. (234 cm).
- Weight with monitor: 460 lbs. (209 kgs) / without monitor: 360 lbs (163 kgs).

## ilex55 Monitor

- Screen Size: 55" (139,7 cm) medical grade TFT LCD (LED) monitor.
- Resolution: 4K UHD resolution 3840 x 2160 pixels 16:9 Aspect.
- Average Brightness: 450 nit.
- Response: 5ms (avg.).
- Weight: 86 lbs. (39 kgs).
- Dimensions: 50.6" (128,4 cm) W x 29.6" (75,2 cm) H x 3.33" (8,45 cm) D.
- Inputs: qty (2) display port 1.02, qty (4) DVI, qty (1) serial and ethernet connection.

## ilex55 alternative image routing option

<b>ilex55 system with IPS1000A video router and tablet (120VAC)</b> The IPS1000A is a video processing system that can scale, reformat, and split video signals capable of 10 inputs and 5 outputs. A touch screen tablet provides fast and easy operation of video management.	A280-0700
<b>ilex55 system with IPS1000A video router and tablet ( 230VAC).</b> The IPS1000A is a video processing system that can scale, reformat, and split video signals capable of 10 inputs and 5 outputs. A touch screen tablet provides fast and easy operation of video management.	A280-0794

## ilex 55 options

<b>DVR Recorder</b> DVR Sony HVO-3300MT Digital Capture System including: 320G hard drive, video streaming, SD & HD inputs video and still image capturing. Plus connecting cables - qty (1) 5" (12,7 cm) DVI cable, 7.5" (19 cm) BNC 75 ohm SDI cable. Requires Routing Control part #280-0794 for use.	C000-1087
<b>Printer</b> Sony UPD80MD digital printer featuring 300 dpi thermal head printing, multi-modality GE formats, and networking capabilities. Unit requires a digital DVR input source from router. Requires Routing Control items for use.	C000-1088

## ilex55 Installation Options

Installation by IDI in continental US. Includes one-day operator training.	Y-ILEXINS01
Installation by IDI in Alaska or Hawaii, including one-day operator training.	Y-ILEXINS02

# ilex32 4K video monitor and stand



## ilex32 4K Description

The Ilex32 4K monitor and stand provides a cost effective solution for those customers requiring an additional UHD 4K monitor or monitors with mirrored images in multiple locations. Designed for use as a large table side monitor, the ilex 32 4K combines practical features with easy use.

## ilex32 4K # A280-0821 120/230 VAC)

Includes the following:

- 31.5" (80 cm) UHD 4K display features signal input options for HDMI, DVI, Display Port plus DC out power for smaller components.
- Single or split-screen images.
- Heavy duty cart stand with tilt [Maximum height: 76" (193 cm) to top of monitor].
- Cable channel.
- Accessory basket.
- 15 foot (4,57 m) power cord (For use outside the USA please specify plug type).
- Cable hook.
- Qty. (1) C-Arm kit including a pair of input cables qty 2.
- One year parts and labor warranty.

## ilex32 4K Installation options

The customer typically performs installation. Installation is not available outside of the United States. For Dealers who choose to have IDI perform the installation:

<b>ilex32 4K Installation by IDI in the continental US</b> Installation by IDI in continental US. Includes one-day operator training.	Y-ILEXINSO1
<b>ilex32 4K Installation by IDI in Alaska or Hawaii</b> Installation by IDI in Alaska or Hawaii, including one-day operator training.	Y-ILEXINSO2

# ilex32 video monitor and stand

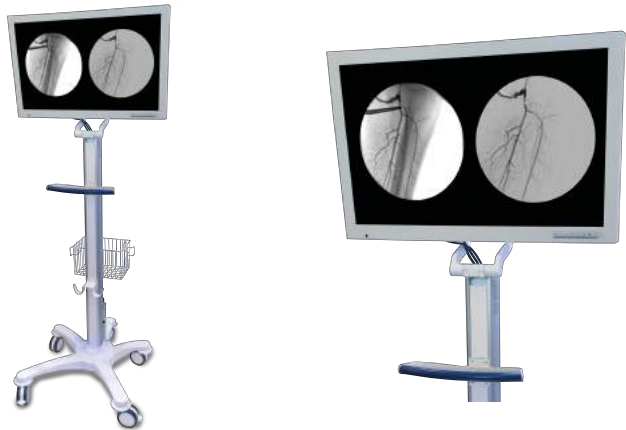

## ilex32 Description

The ilex32 monitor and stand provides a cost effective solution for those customers requiring an additional monitor or monitors with mirrored images in multiple locations.

- 120VAC is standard
- 230VAC is optional and must be specified at time of order

## ilex32 # A280-0630 (120VAC) #A280-0743 (230 Volt)

Includes the following:

- 32”(81 cm) HD medical grade monitor with medical bios and input options for Dual SOG, Dual DVI, VGA, SDI, S Video.
- Single or split-screen images.
- Heavy duty cart stand with tilt [Maximum height: 76” (193cm) to top of monitor].
- Cable channel.
- Accessory basket.
- 15 foot (4,57 m) power cord.
- Cable hook.
- Qty. (1) C-Arm kit including a pair of input cables qty 2.
- One year parts and labor warranty.

## ilex32 Installation options

The customer typically performs installation. Installation is not available outside of the United States. For Dealers who choose to have IDI perform the installation:

<b>ilex32 Installation by IDI in the continental US</b> Installation by IDI in continental US. Includes one-day operator training..	Y-ILEXINSO1
<b>ilex32 Installation by IDI in Alaska or Hawaii</b> Installation by IDI in Alaska or Hawaii, including one-day operator training.	Y-ILEXINSO2

## ilex C video stand with accessory rail



Shown with motorized C-Arm control panels

### ilex C Description # A280-0893

The IlexC is a video stand for mounting motorized C-Arm control panels, patient monitoring and other accessory rail-mounted devices. Load capacity: 30 lbs (13,6 kgs). Complete with adjustable U.S. or metric 12" (30,5 cm) medical accessory rail and accessory basket.

- Two locking casters.
- Utility basket with cable wraps.
- 12" (30,5 cm) adjustable medical accessory rail (U.S. or metric standard).
- Accessory rail is 42" (106,7 cm) from the floor.
- Control handle.
- Up to 30 lbs (13 kgs) capacity.
- Approximately 22" x 23" (56 cm x 58 cm) footprint.

### ilex C Dimensions

Note: Mounting rails are metric:  $\frac{3}{8}$ " x  $1\frac{1}{8}$ " (10 mm x 25 mm).

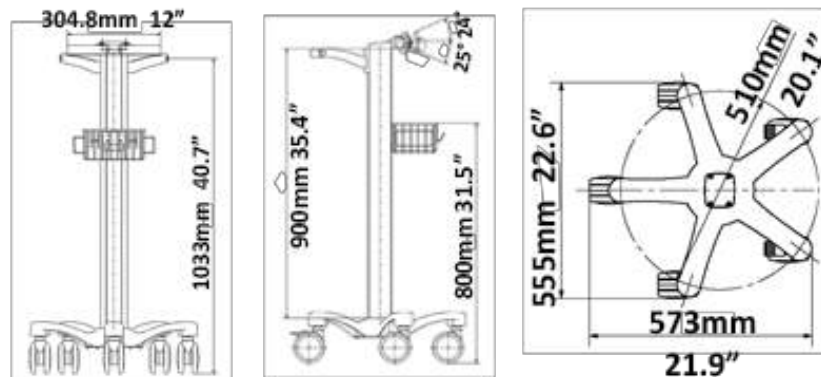



## Connexus Direct Connect video transmission



### Connexus Direct Connect Description # A280-0916

Wall mounted signal conversion system for up to two channels of uncompressed, encrypted HD video. Attach C-Arm control cart video cables to the Connexus Direct Connect via DVI-I connectors on the top of the unit to transmit left and right channel C-Arm signals to any location in a room; wall monitor, boom monitors or IDI's Ilex55, Ilex32 4K or Ilex 32 video integration systems.

### Connexus Direct Connect Dimensions/Weight

Weight: 17 lbs (7,7 kgs)

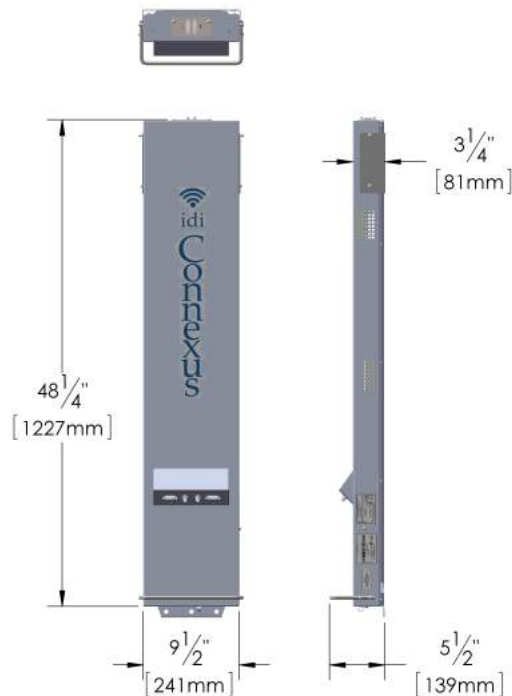

## SIMEON Lighting Systems

### Sim.LED 4500 Mobile Light



### Sim.LED 4500 Mobile Light Description #K400-0103

The **Sim.LED 4500** is the ideal light for outpatient and plastic surgery. This light provides ideal illumination, uniform light and very good depth illumination.

### Sim.LED 4500 Mobile Light Technical Data

Central illumination intensity at a distance of 1 meter [lx]	100,000
Electrical dimmability from/to [lx]	25,000 – 100,000
Color temperature [K]	4,500
Field size d10 at a distance of 1 meter [mm]	170
Color rendering index Ra	96
Red rendering index R9	96
Illumination depth without refocusing (L1/L2) [mm]	1,530
Light head weight [kg]	3
Light head power consumption [W]	28
No. of LEDs	18
Approval	CE
LED lifespan [h]	> 60,000

Tolerance  $\pm 10\%$

Technical specifications are subject to change

## More SIMEON Lighting Systems

IDI offers a wide variety of premium O.R. Light options from SIMEON Medical. [CLICK HERE](#) to see all of IDI's SIMEON lighting systems.

## SIMEON Highline Lighting Systems Examples



[Highline OR Lights Online](#)

## SIMEON Businessline Lighting Systems Examples

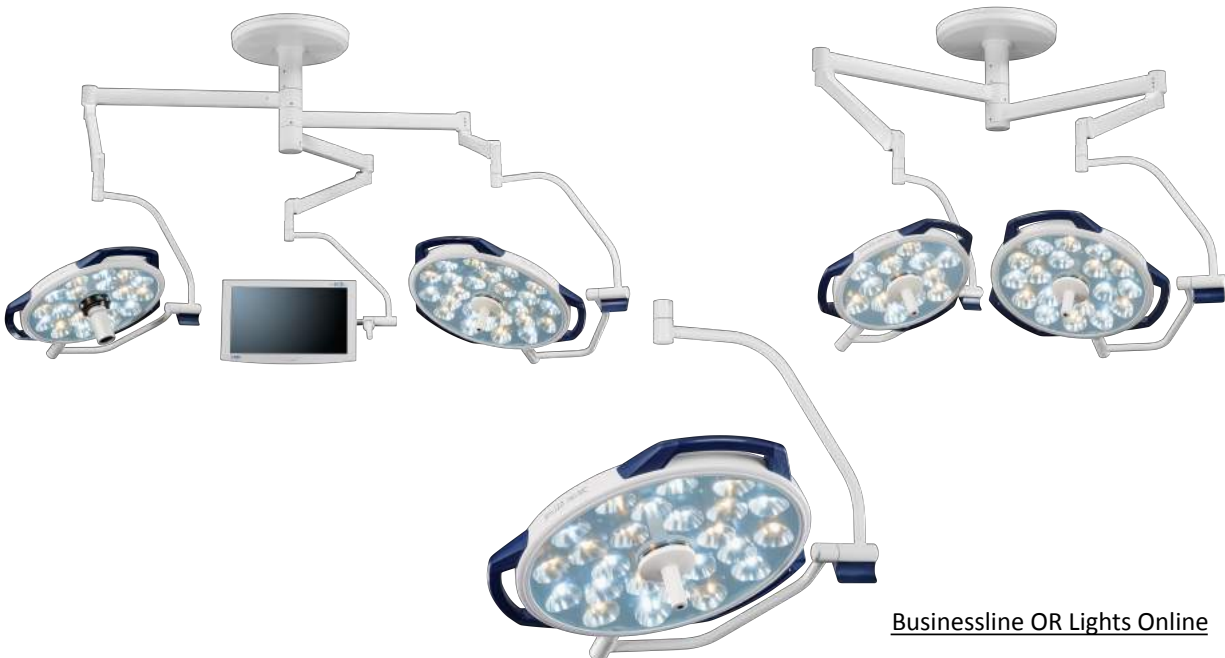

[Businessline OR Lights Online](#)

## Aspect Four-Way Float Table Specifications & Accessories

•=Standard feature ◊=Optional NA=Not available	<b>100 - 4</b>	<b>100 - 4T G3</b>	<b>ISR G3</b>
<b>Elevate (Height with 2" pad)</b>	29.9 - 39.7" 76 - 101 cm	32-45" 81-114 cm	33-45" 84-114 cm
<b>Trendelenburg Tilt</b>	NA	±12°	±12°
<b>Lateral Tilt</b>	NA	NA	±12°
<b>Longitudinal Tabletop Motion</b>	40" float 102 cm	32" float 81 cm	32" float 81 cm
<b>Transverse Tabletop Motion</b>	10" float 25 cm	8" float 20 cm	8" float 20 cm
<b>Standard Tabletop Size</b>	21/30" x 80" 53/76 cm x 203 cm	24"/22"/19.5" x 84" 61/56/50 cm x 213cm	24"/22"/19.5" x 84" 61/56/50 cm x 213cm
<b>Imaging Area</b>	72" 183 cm	68" / 173 cm  80" (203 cm) with optional peripheral extension	68" / 173 cm  80" (203 cm) with optional peripheral extension
<b>Patient Capacity</b>	450 lbs (204 kgs)	600 lbs (272 kgs)	600 lbs (272 kgs)
<b>Table Weight</b>	490 lbs 222 kgs	605 lbs 274 kgs	605 lbs 274 kgs
<b>Tabletop Pad</b>	•	•	•
<b>Restraint Straps</b>	•	•	•
<b>Pendant Hand Control</b>	NA	•	•
<b>4-way Panning Hand Control</b>	•	•	•
<b>Foot Control</b>	NA	◊	◊
<b>Battery operation</b>	Backup for elevation only	• Up to 5 days Will vary based on case load and patient size	• Up to 5 days Will vary based on case load and patient size
<b>Armboard, rail mounted</b>	NA	◊	◊
<b>Armboard, carbon fiber</b>	◊	◊	◊
<b>VAB Armboard</b>	◊	◊	◊
<b>Clamp-on Accessory Rail</b>	◊	◊	◊
<b>Catheter Tray extension</b>	◊	◊	◊
<b>Peripheral Extension</b>	NA	◊	◊
<b>Headrest extension</b>	NA	◊	◊
<b>Table-Mounted Radiation Shield</b>	◊	◊	◊
<b>Anesthesia Screen Holder</b>	NA	◊	◊
<b>IV Pole</b>	◊	◊	◊

## Aspect Urology & GYN Table Specifications & Accessories

•Standard feature ◊Optional NA Not available	<b>100 UC-Plus</b>	<b>100 US</b>
<b>Elevate (Height with pad)</b>	33.3" – 43.1" (84.5 – 109.4 cm)	27" – 39" (68.5 – 99cm)
<b>Trendelenburg Tilt</b>	± 15°	NA
<b>Transverse travel</b>	± 3.5 - 7" total (± 8.9 cm - 17,8 cm total)	NA
<b>Longitudinal Tabletop Motion</b>	10" (25,4 cm)	NA
<b>Tabletop Size</b>	28"W x 46"L (71 x 117 cm)	24"W x 46"L (61 x 117 cm)
<b>Tabletop Extension Size</b>	24"W x 34"L (61 x 86 cm)	NA
<b>Imaging Area</b>	Main tabletop: 25"W x 20"L (63,5 x 50,8 cm)	22"W x 32"L (56 x 81 cm)
<b>Imaging Area with table extension</b>	54" (137 cm)	NA
<b>Patient Weight Capacity</b>	Upper body on main table: 525 lbs (238 kgs) Upper body on extension: 400 lbs (181 kgs) Load capacity on extension only: 200 lbs (90,7kgs)	450 lbs (204 kgs)
<b>Table Weight</b>	490 lbs (222 kgs)	375 lbs (170 kgs)
<b>Tabletop Pad 2" (5 cm) thick</b>	•	•
<b>Tabletop extension with pad</b>	•	Leg support tabletop extension
<b>Hand control pendant &amp; footswitch control</b>	•	Footswitch only
<b>Patient restraint straps</b>	•	•
<b>Removeable drain bag support hoop</b>	•	NA
<b>Disposable drain bag &amp; hose assembly, box of 20</b>	•	NA
<b>Removable radiation shield flap for perineal end of table</b>	•	NA
<b>Armboard, rail-mounted with pad and strap</b>	•	◊
<b>Split Leg Stirrups</b>	◊	NA
<b>Disposable covers for footswitch, box of 50</b>	•	◊
<b>Radiographic cassette tray</b>	◊	NA

## Aspect Pain Management Table Specifications & Accessories

•Standard feature ◊Optional NA Not available	100E	100T	100RT	100RTL
<b>Elevate Height with 2" (5 cm) pad</b>	28 - 39.8" 71 - 101 cm	30 - 41.8" 76 - 106 cm	32.4 - 44.2" 82 - 112 cm	31.2 - 41.2" 79.2 - 104,6 cm
<b>Trendelenburg Tilt</b>	NA	±15°	±15°	±15°
<b>Lateral Tilt</b>	NA	NA	20°	20°
<b>Longitudinal Tabletop Motion</b>	NA	NA	NA	10"
<b>Standard Tabletop Size</b>	24" x 80" 61 x 203 cm	24" x 80" 61 x 203 cm	24" x 80" 61 x 203 cm	24" x 80" 61 x 203 cm
<b>Optional Tabletop Size</b>	22" x 80" 56 x 203 cm with facial cut-out	22" x 80" 56 x 203 cm with facial cut-out	22" x 80" 56 x 203 cm with facial cut-out	22" x 80" 56 x 203 cm with facial cut-out
<b>Optional GI Tabletop Size</b>	28" x 80" 71 x 203 cm	28" x 80" 71 x 203 cm	28" x 80" 71 x 203 cm	28" X 80" 71 x 203 cm
<b>Imaging Area</b>	66" 167,6 cm	62" 157,5 cm	62" 157,5 cm	59" 149,9 cm
<b>Patient Capacity</b>	450 lbs 204 kgs	450 lbs 204 kgs	450 lbs 204 kgs	450 lbs 204 kgs
<b>Table Weight</b>	290 lbs 131 kgs	325 lbs 147 kgs	380 lbs 172 kgs	355 lbs 161 kgs
<b>Tabletop Pad 2" (5 cm) thick</b>	•	•	•	•
<b>Restraint Straps</b>	•	•	•	•
<b>Facial Support Cushion</b>	•	•	•	•
<b>Pendant Hand Control</b>	•	•	•	•
<b>Foot Control</b>	◊	◊	◊	◊
<b>Armboard, rail mounted</b>	◊	◊	◊	◊
<b>Armboard, carbon fiber</b>	◊	◊	◊	◊
<b>VAB Armboard</b>	◊	◊	◊	◊
<b>Clamp-on Accessory Rail</b>	◊	◊	◊	◊
<b>Scatter-Guard Radiation Shield</b>	◊	◊	◊	◊

## Image Diagnostics, Inc.

Since 1986, IDI has been a manufacturer of innovative products for surgical, interventional and diagnostic imaging.

Our product focus is in electro-mechanical solutions for fluoroscopic and digital radiographic applications.

IDI is committed to superior product design, value and customer support in everything we do.

### Image Diagnostics, Inc.

310 Authority Drive  
Fitchburg, Massachusetts  
01420

For customer service:  
[sales@imagediagnostics.com](mailto:sales@imagediagnostics.com)

Toll free: 877.304.5434  
Main: 978.829.0009  
Fax: 978.829.0027

[ImageDiagnostics.com](http://ImageDiagnostics.com)

# idi

Image Diagnostics Inc.



A Veteran-Owned Business